



Precision grinding.

Grinders are the marathon runners of power tools. Whereas the loads for screwdriving and drilling generally involve brief peaks of output, grinding, finishing and cutting work more often imposes a lasting load on both operator and tool alike. All FEIN power grinders are therefore designed to reduce physical loads, for mechanical durability and operator safety. They are particularly convenient and lightweight to use. They are fitted with air cooled universal motors which are protected against overload.

In addition to the classical angle grinders range of 650 to 2500 W, with or without FEIN rapid clamping system, and the straight grinders, FEIN offers a broad range of special equipment. These are power tools that have been designed precisely for the special needs of users in various

trades. The best examples being the FEIN angle polisher and the FEIN pipe sander for perfectly processing stainless steel surfaces as well as the FEIN construction cutter, which enhances the efficiency of old window renovations.

The complete FEIN program for sanding:

-
- **Angle grinders** p. 122
 - **Construction cutter** p. 144
 - **Angle polishers** p. 148
 - **Pipe sander** p. 151
 - **Straight grinders** p. 155
 - **Sanders with dust extraction** p. 187
-



Easier all around: FEIN Power Tools for working of stainless steel.



Universal application - FEIN straight grinder for grinding, polishing, milling, drilling etc.













Revolution in window dismantling: quickly and precisely, and practically dust-free with just one cut.

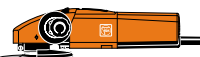

Safe sanding with dust extraction.

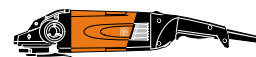



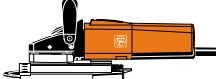
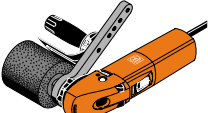
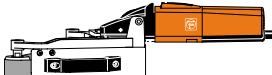

The Right Choice Made Easy.

Angle Grinders

Type	Power Watt	Speed no load R.P.M.	Disc Ø max mm	METAL-WORKING cutting	grinding roughing	Cleaning deburring rust removal	brushing	STAINLESS STEEL polishing, matting, polishing etc.	MASONRY cutting
Page 122									
 WSS 6.5-115	650	11 000	115	●	●●	●●	●	-	●
Page 124									
 WSS 12-125	1200	10 000	125	●●	●●	●●	●	-	●
Page 126									
 WSG 12-125	1200	7000	125	●●	●●	●●	●●	-	●
 WSG 12-150	1200	7000	150	●●	●●	●●	●	-	●
Page 128									
 MSfv 649	750	12 000	125	●●	●●	●●	-	-	-
Page 130									
 WSG 12-70 E	1200	2700-7000	125	●	●●	●●	●●	-	●
Page 132									
 WSG 20-180	2000	8500	180	●	●●	●●	●●	-	●
Page 134									
 WSG 20-230	2000	6600	230	●●	●●	●●	●●	-	●●
Page 136									
 WSB 20-180	2000	8500	180	●	●●	●●	●●	-	●
Page 138									
 WSB 20-230	2000	6600	230	●●	●●	●●	●	-	●●
Page 140									
 WSB 25-180 X	2500	8500	180	●	●●	●●	●●	-	●
Page 142									
 WSB 25-230 X	2500	6600	230	●●	●●	●●	●	-	●●
Construction Cutter									
Page 144									
 MF 12-180	1200	7000	180	●	-	-	-	-	●●
Angle Polisher									
Page 146/147									
 WPO 12-27 E	1200	900-2700	200	-	-	-	●	●●	-
Pipe Sander									
Page 151/152									
 RS 12-70 E	1200	2700-7000		-	-	-	-	●●	-

●● very good ● good - not possible

Straight Grinders



Type	Power Watt	Speed no load R.P.M.	Wheel Ø max mm	Tool holder	METAL-WORKING					
					grinding roughing	cleaning deburring rust removal	brushing	polishing	milling	
Page 154										
 AHSl 636 c	280	4500	50	Chuck	●	●	-	-	-	
				Chuck	-	-	●●	●●	-	
				Chuck	-	-	●	●●	-	
Page 156										
 MSh 635	350	45 000	13	Collet	●●	-	-	-	●●	
Page 157										
 MSh 636-1	280	28 000	20	Collet	●●	-	-	-	●●	
Page 159										
 MSh 648	650	23 000	25	Collet	-	-	-	-	●●	
			36	Collet	●●	●●	-	-	-	
			50	Collet	●●	●●	-	-	-	
Page 160										
 MShy 648 Z	650	5200	50	Collet	●	●	●●	●●	●	
			75	Collet	-	-	-	●●	-	
Page 162/163										
 MShy 649	750	8300	100	Flange	●●	●●	-	●●	-	
			125	Flange	●●	-	-	-	-	
 MShy 664	1400	6900	125	Flange	●●	-	-	-	-	
			125	Flange	●●	-	-	-	-	

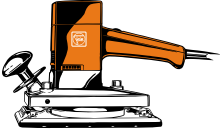

Orbital Sanders

Type	Power Watt	Speed no load 1/min	Stoke mm	Sanding pad mm	Pneumatic version	Application small surfaces	medium surfaces	large surfaces
Page 167								
 MSs 641 a	500	14000	5	115 x 225	-	-	●●	●
							MSs 641 b	500

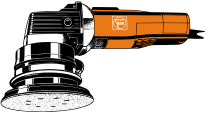
Random Orbit Sander

Page 169								
 MSf 636-1	380	7500	8,4	Ø 150	-	●	●●	-
Page 170								
 M 10000-5	-	10000	5	Ø 125	X	●	●●	-
							M 10000-6	-

Rotary Sander

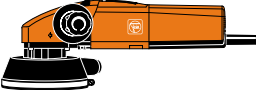
Page 174								
 FSS 12-27 E	1200	900-2700	-	Ø 150 / 200	-	-	●	●●



Quick IN



Angle Grinder, 650 W

WSS 6.5-115
FEIN HIGH-POWER MOTOR, QuickIN

Order Reference		7 220 89
Type		WSS 6.5-115
Input	W	650
Output	W	450
Speed, no load	R.P.M.	11 000
Cable with plug	m	4
Net weight	kg	1,5
Grinding wheel Ø	mm	115
Elast. Backing pad Ø	mm	115
Mounting hole Ø	mm	22,23

Price includes:

1 wheel guard, 1 clamp for flexible grinding/cutting wheels, 1 additional handle

	115 mm		11 000
	650 W		1,5 kg

AT A GLANCE

Easy-to-use angle grinder in the 115 mm class with excellent performance.

- Compact shape and low weight for optimum handling and fatigue-free working.
- HIGH-POWER-MOTOR with enormous torque for high grinding capacity.
- FEIN rapid attachment system QuickIN for fast, simple and reliable disk changes with no tools required.
- Self-start lock prevents uncontrolled reactivation following power supply interruption.
- Safety catch prevents accidental activation.
- Gentle start for recoil-free and safe starting.
- Easily adjustable and unremovable wheel guard.

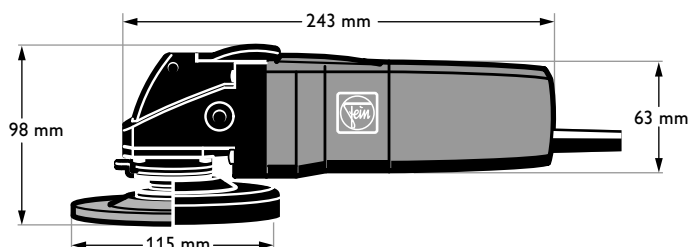

Accessories on page 123.

Roughing-down

Flexible Grinding Wheel
for steel, 80 m/s



Ø mm	Width mm	Order Reference
115	4	6 37 10 018 00 2

Cutting

Flexible cutting wheels
for steel, 80 m/s



Ø mm	Width mm	Order Reference
115	2,5	6 37 09 012 00 8

for stone, 80 m/s

Ø mm	Width mm	Order Reference
115	2,5	6 37 09 011 00 5

Clamping unit

for flexible grinding/cutting wheels, circular twisted steel wire brush and fan-pattern grinding wheels

Order Reference 6 38 02 178 02 3

Sanding

Elastic backing pad
without clamping unit



Ø mm	Order Reference
115	6 38 06 143 01 7

Fibre sanding discs

for backing pads, Ø 115 mm



Grain	VE	Order Reference
24	25	6 37 17 067 01 6
36	25	6 37 17 068 01 4
40	25	6 37 17 177 01 4
50	25	6 37 17 069 01 8
60	25	6 37 17 178 01 2
80	25	6 37 17 070 01 0
100	25	6 37 17 196 01 8
120	25	6 37 17 071 01 9

Clamping unit

for elastic backing pad and for twisted steel wire brush



Order Reference 6 38 02 180 02 9

Brushing

Tapered twist brush
100 mm Ø



Order Reference 6 37 22 045 01 9

Round twist brush

Ø 115 mm



Order Reference 6 37 22 043 01 7

Further accessories

Carrying case
metal
390 x 210 x 140 mm

Order Reference 3 39 01 045 01 8





Quick IN



■ Compact Angle Grinder 1200 W

WSS 12-125
FEIN HIGH-POWER MOTOR, QuickIN

Order Reference		7 220 88
Type		WSS 12-125
Input	W	1200
Output	W	750
Speed, no load	R.P.M.	10 000
Cable with plug	m	4
Net weight	kg	1,9
Grinding wheel Ø	mm	125
Elast. Backing pad Ø	mm	115/125
Mounting hole Ø	mm	22,23

Price includes:

1 wheel guard, 1 clamp for flexible grinding/cutting wheels, 1 additional handle

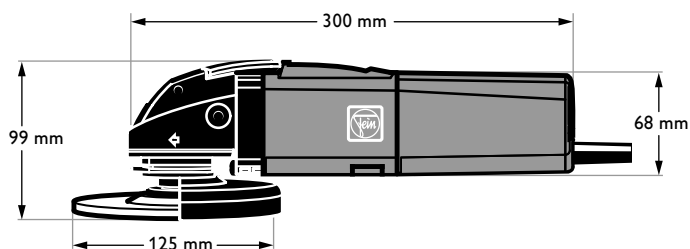

	125 mm		10 000
	1200 W		1,9 kg

AT A GLANCE

Compact angle grinder in the 125 mm class with excellent performance.

- HIGH-POWER-MOTOR with enormous torque for high grinding capacity.
- For all grinding, sanding, cutting and brushing applications.
- FEIN rapid attachment system QuickIN for fast, simple and reliable disk changes with no tools required.
- Self-start lock prevents uncontrolled reactivation following power supply interruption.
- Gentle start for recoil-free and safe starting.
- Easily adjustable and unremovable wheel guard.

Accessories on page 125.

Roughing-down

Flexible Grinding Wheel

for steel, 80 m/s



Ø mm	Width mm	Order Reference
115	4	6 37 10 018 00 2
125	6	6 37 10 012 00 1

Cutting

Flexible cutting wheels

for steel, 80 m/s



Ø mm	Width mm	Order Reference
115	2,5	6 37 09 012 00 8
125	2,5	6 37 09 007 00 2

for stone, 80 m/s

Ø mm	Width mm	Order Reference
115	2,5	6 37 09 011 00 5
125	2,5	6 37 09 008 00 0

Clamping unit

for flexible grinding/cutting wheels, circular twisted steel wire brush and fan-pattern grinding wheels

Order Reference 6 38 02 178 02 3

Sanding

Elastic backing pad

without clamping unit



Ø mm	Order Reference
115	6 38 06 143 01 7
125	6 38 06 138 01 5

Fibre sanding discs

for backing pads, Ø 115 mm



Grain	VE	Order Reference
24	25	6 37 17 067 01 6
36	25	6 37 17 068 01 4
40	25	6 37 17 177 01 4
50	25	6 37 17 069 01 8
60	25	6 37 17 178 01 2
80	25	6 37 17 070 01 0
100	25	6 37 17 196 01 8
120	25	6 37 17 071 01 9

for elastic backing pad, Ø 125 mm

Grain	VE	Order Reference
24	25	6 37 17 074 01 4
36	25	6 37 17 075 01 8
40	25	6 37 17 076 01 1
50	25	6 37 17 180 01 8
60	25	6 37 17 077 01 5
80	25	6 37 17 078 01 3
100	25	6 37 17 079 01 7
120	25	6 37 17 197 01 2

Clamping unit

for elastic backing pad and for twisted steel wire brush



Order Reference 6 38 02 180 02 9

Fan-pattern sanding wheels

Ø 125 mm



Grain	VE	Order Reference
40	10	6 37 30 004 01 0
60	10	6 37 30 005 01 4
80	10	6 37 30 006 01 7

Brushing

Tapered twist brush

Ø 115 mm



Order Reference 6 37 22 046 01 2

Round twist brush

Ø 125 mm



Order Reference 6 37 22 044 01 5

Further accessories

Carrying case

metal
390 x 210 x 140 mm

Order Reference 3 39 01 045 01 8





Angle Grinder 1200 W

WSG 12-125
FEIN HIGH-POWER MOTOR

WSG 12-150
FEIN HIGH-POWER MOTOR

Order Reference		7 220 96	7 220 93
Type		WSG 12-125	WSG 12-150
Input	W	1200	1200
Output	W	750	750
Speed, no load	R.P.M.	7000	7000
Cable with plug	m	4	4
Net weight	kg	2,1	2,1
Grinding wheel Ø	mm	125	150
Elast. Backing pad Ø	mm	125	150
Mounting thread	M	14	14

Price includes:

1 wheel guard, 1 pair of flanges, 1 additional handle, 1 key

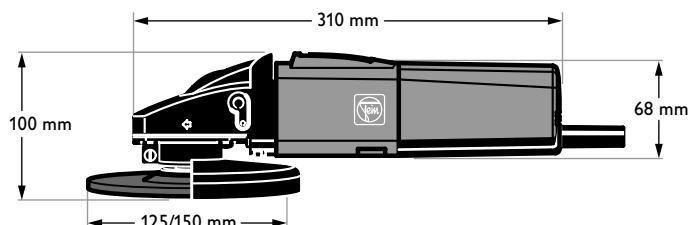

125/150 mm
 7000

 1200 W
 2,1 kg

AT A GLANCE

Compact angle grinder with M 14 spindle.

- HIGH-POWER-MOTOR with enormous torque for high grinding capacity.
- For all grinding, sanding, cutting and brushing applications.
- Self-start lock prevents uncontrolled reactivation following power supply interruption.
- Gentle start for recoil-free and safe starting.
- Spindle brake for quick tool changes.

Roughing-down

Flexible Grinding Wheel
for steel, 80 m/s



Ø mm	Width mm	Order Reference
115	4	6 37 10 018 00 2
125	6	6 37 10 012 00 1

Cutting

Flexible cutting wheels
for steel, 80 m/s



Ø mm	Width mm	Order Reference
115	2,5	6 37 09 012 00 8
125	2,5	6 37 09 007 00 2

for stone, 80 m/s

Ø mm	Width mm	Order Reference
115	2,5	6 37 09 011 00 5
125	2,5	6 37 09 008 00 0

Threaded flange

M 14, for flexible grinding/cutting wheels, circular twisted steel wire brush and fan-pattern grinding wheels



Order Reference 6 38 02 052 00 0

Inner flange



Order Reference 6 38 01 120 00 6

Sanding

Elastic backing pad
with flange M 14



Ø mm	Order Reference
125	6 38 06 087 01 3

Fibre sanding discs

for elastic backing pad, Ø 125 mm



Grain	VE	Order Reference
24	25	6 37 17 074 01 4
36	25	6 37 17 075 01 8
40	25	6 37 17 076 01 1
50	25	6 37 17 180 01 8
60	25	6 37 17 077 01 5
80	25	6 37 17 078 01 3
100	25	6 37 17 079 01 7
120	25	6 37 17 197 01 2

Backing pad

Ø 125 mm with hook and loop fastener, M 14



Order Reference 6 38 06 168 01 2

Sanding sheets

Ø 125 mm, with hook and loop quick-attachment fitting backing pad
6 38 06 168 01 2



Grain	VE	Order Reference
24	25	6 37 28 099 01 5
36	25	6 37 28 100 01 6
40	25	6 37 28 101 01 5
50	25	6 37 28 102 01 8
60	25	6 37 28 103 01 2
80	25	6 37 28 104 01 0
100	25	6 37 28 105 01 4
120	25	6 37 28 106 01 7

Fan-pattern sanding wheels

Ø 125 mm



Grain	VE	Order Reference
40	10	6 37 30 004 01 0
60	10	6 37 30 005 01 4
80	10	6 37 30 006 01 7

Ø 150 mm

Grain	VE	Order Reference
40	10	6 37 30 007 01 1
60	10	6 37 30 008 01 9
80	10	6 37 30 009 01 3

Brushing

Tapered twist brush

Ø 115 mm



Order Reference 6 37 22 046 01 2

Threaded flange

M 14



Order Reference 6 38 01 154 00 7

Round twist brush

Ø 125 mm



Order Reference 6 37 22 044 01 5

Threaded flange

M 14, for flexible grinding/cutting wheels, circular twisted steel wire brush and fan-pattern grinding wheels



Order Reference 6 38 02 052 00 0

Twist cup brush

Ø 65 mm, M 14



Order Reference 6 37 22 047 01 6

Further accessories

Carrying case

metal
390 x 210 x 140 mm



Order Reference 3 39 01 045 01 8





■ Angle Grinder, 750 W





MSfv 649

Order Reference	7 220 01	
Type	MSfv 649	
Input	W	750
Output	W	480
Speed, no load	R.P.M.	12 000
Cable with plug	m	5
Net weight	kg	3,5
Grinding wheel Ø	mm	125
Mounting thread	M	14

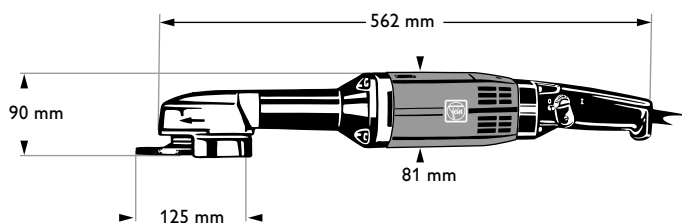
Price includes:

1 wheel guard, 1 pair of flanges, 1 set of keys



	125 mm		12 000
	750 W		3,5 kg

AT A GLANCE

Long-necked angle grinder with spindle M 14 for working in difficult-to-reach areas.

- Very flat drive head, including grinding disc.
- Two-handed machine for safe and easy handling.

Roughing-down

Flexible Grinding Wheel

for steel, 80 m/s



Ø mm	Width mm	Order Reference
115	4	6 37 10 018 00 2
125	6	6 37 10 012 00 1

Cutting

Flexible cutting wheels

for steel, 80 m/s



Ø mm	Width mm	Order Reference
115	2,5	6 37 09 012 00 8
125	2,5	6 37 09 007 00 2

for stone, 80 m/s

Ø mm	Width mm	Order Reference
115	2,5	6 37 09 011 00 5
125	2,5	6 37 09 008 00 0

Further accessories

Carrying case

metal

700 x 180 x 100 mm



Order Reference **3 39 01 021 01 1**

Inner flange

for wheels Ø 125 mm

Order Reference **6 38 01 079 00 9**

Threaded flange

M 14, for wheels up to 6 mm

Order Reference **6 38 02 084 00 9**

M 14, for wheels up to 8 mm

Order Reference **6 38 02 103 00 8**





Angle Grinder 1200 W

WSG 12-70 E
FEIN HIGH-POWER MOTOR

Order Reference	7 220 90	
Type	WSG 12-70 E	
Input	W	1200
Output	W	750
Speed, no load	R.P.M.	2700-7000
Cable with plug	m	4
Net weight	kg	2,1
Grinding wheel Ø	mm	125
Mounting thread	M	14
Elast. Backing pad Ø	mm	125

Price includes:

1 wheel guard, 1 pair of flanges, 1 additional handle, 1 key

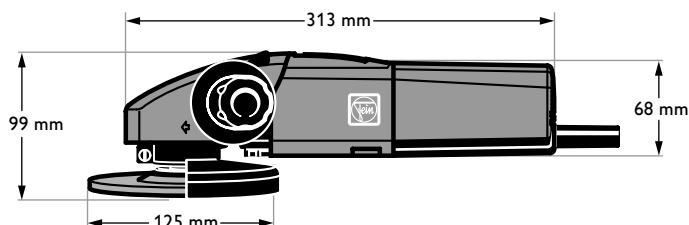

	125 mm		2700-7000
	1200 W		2,1 kg

AT A GLANCE

Compact angle grinder/sander with M 14 spindle.

- HIGH-POWER-MOTOR with enormous torque for high grinding capacity.
- Variable electronic speed control for sensitive screwdriving applications.
- Wide range of uses thanks to large speed range (e.g. for stainless steels).
- Self-start lock prevents uncontrolled reactivation following power supply interruption.
- Gentle start for recoil-free and safe starting.
- In conjunction with the angle polisher WPO 12-27 E, makes an ideal surface finishing treatment combination.
- Spindle brake for quick tool changes.

Accessories on page 131.



Roughing-down

Flexible Grinding Wheel
for steel, 80 m/s



Ø mm	Width mm	Order Reference
125	6	6 37 10 012 00 1

Cutting

Flexible cutting wheels
for steel, 80 m/s



Ø mm	Width mm	Order Reference
125	2,5	6 37 09 007 00 2

for stone, 80 m/s

Ø mm	Width mm	Order Reference
125	2,5	6 37 09 008 00 0

Threaded flange

M 14, for flexible grinding/cutting wheels, circular twisted steel wire brush and fan-pattern grinding wheels

Order Reference 6 38 02 052 00 0

Inner flange

Order Reference 6 38 01 120 00 6

Sanding

Elastic backing pad
with flange M 14



Ø mm	Order Reference
125	6 38 06 087 01 3

Fibre sanding discs

for elastic backing pad, Ø 125 mm



Grain	VE	Order Reference
24	25	6 37 17 074 01 4
36	25	6 37 17 075 01 8
40	25	6 37 17 076 01 1
50	25	6 37 17 180 01 8
60	25	6 37 17 077 01 5
80	25	6 37 17 078 01 3
100	25	6 37 17 079 01 7
120	25	6 37 17 197 01 2

Backing pad

Ø 125 mm with hook and loop fastener, M 14



Order Reference 6 38 06 168 01 2

Sanding sheets

Ø 125 mm, with hook and loop quick-attachment fitting backing pad 6 38 06 168 01 2

Grain	VE	Order Reference
24	25	6 37 28 099 01 5
36	25	6 37 28 100 01 6
40	25	6 37 28 101 01 5
50	25	6 37 28 102 01 8
60	25	6 37 28 103 01 2
80	25	6 37 28 104 01 0
100	25	6 37 28 105 01 4
120	25	6 37 28 106 01 7

Backing pad

with hook and loop fastener, for working with abrasive fleece, M 14



Ø mm	Order Reference
115	6 38 06 172 01 0

Sanding fleece

Ø 115 mm, stable, with hook and loop quick-attachment, for use with backing pad 6 38 06 172 01 0



Grain	VE	Order Reference
coarse	10	6 37 32 001 01 8
medium	10	6 37 32 002 01 1
fine	10	6 37 32 003 01 5

Fan-pattern sanding wheels

Ø 125 mm



Grain	VE	Order Reference
40	10	6 37 30 004 01 0
60	10	6 37 30 005 01 4
80	10	6 37 30 006 01 7

Brushing

Tapered twist brush
Ø 115 mm



Order Reference 6 37 22 046 01 2

Threaded flange

M 14

Order Reference 6 38 01 154 00 7

Round twist brush

Ø 125 mm



Order Reference 6 37 22 044 01 5

Twist cup brush

Ø 65 mm, M 14



Order Reference 6 37 22 047 01 6

Safety guard

as hand guard



Order Reference 3 02 29 216 00 5

Suction

Universal dust extraction device

Ø 125 mm, for fan-pattern grinding wheels, elastic backing pads, support plates and conical twisted steel wire brushes



Order Reference 9 26 02 067 01 6

Brush insert

for universal dust extraction device



Order Reference 3 32 18 101 01 4

Protective suction hood

Ø 125 mm for flexible grinding/cutting wheels



Order Reference 9 26 02 068 01 4

FEIN Dust Extractor, movable

for wet and dry use, with automatic switch-on facility, incl. suction hose 3,5 m long, Ø 32 mm



Order Reference 9 20 18 223 01 3

Detailed information on "dust-free sanding" and extensive accessories for the FEIN vacuum cleaner can be found in the chapter Accessories / Vacuum cleaner

Spark catcher

for suction hose Ø 32 mm



Order Reference 3 13 22 489 00 1

General accessory

Carrying case

metal 390 x 210 x 140 mm



Order Reference 3 39 01 045 01 8





Angle Grinders 2000 W

WSG 20-180
FEIN HIGH-POWER MOTOR

Order Reference	7 221 07	
Type	WSG 20-180	
Input	W	2000
Output	W	1250
Speed, no load	R.P.M.	8500
Cable with plug	m	4
Net weight	kg	4,5
Grinding wheel Ø	mm	180
Elast. Backing pad Ø	mm	180
Mounting thread	M	14

Price includes:

1 wheel guard, 1 pair of flanges, 1 additional handle, 1 set of keys

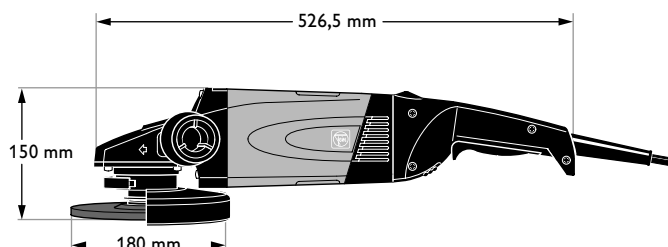

180 mm	8500
2000 W	4,5 kg

AT A GLANCE

Efficient angle grinder in the 2000 W class with M 14 spindle.

- HIGH-POWER-MOTOR with enormous torque for high grinding capacity.
- Self-start lock prevents uncontrolled reactivation following power supply interruption.
- Gentle start for recoil-free and safe starting.
- For all grinding, sanding, cutting and brushing applications.
- Most noiseless angle grinder in this class.
- Flattest drive head in this performance class.
- Rear handle can be rotated through 4 positions.
- Coolant air management offers optimum protection against dust.

Also available with dead-man's handle for maximum safety (7 221 10 29 and 7 221 11 29).



Roughing-down

Flexible grinding wheels
for steel, 80 m/s



Ø mm	Width mm	Order Reference
180	6	6 37 10 001 00 9
180	8	6 37 10 009 00 7

for non-ferrous metal, 80 m/s

Ø mm	Width mm	Order Reference
180	6	6 37 10 003 00 6

for stone, 80 m/s

Ø mm	Width mm	Order Reference
180	8	6 37 10 010 00 9

Cutting

Flexible cutting wheels
for steel, 80 m/s



Ø mm	Width mm	Order Reference
180	3,2	6 37 09 001 00 6

for stone, 80 m/s

Ø mm	Width mm	Order Reference
180	3,2	6 37 09 002 00 9

Threaded flange

M 14, for flexible grinding/cutting wheels, circular twisted steel wire brush and fan-pattern grinding wheels



Order Reference 6 38 02 052 00 0

Inner flange



Order Reference 6 38 01 120 00 6

Protective suction hood

with guide block for cutting wheels
Ø 180 mm cutting depth 40 mm,
connection Ø 32 mm



Order Reference 9 06 04 008 01 3

FEIN Dust Extractor, movable

for wet and dry use, with automatic switch-on facility,
incl. suction hose 3,5 m long, Ø 32 mm



Order Reference 9 20 18 223 01 3

Detailed information on "dust-free sanding" and extensive accessories for the FEIN vacuum cleaner can be found in the chapter Accessories / Vacuum cleaner

Fan-pattern sanding wheels
Ø 180 mm



Grain	VE	Order Reference
40	10	6 37 30 011 01 4
60	10	6 37 30 012 01 7
80	10	6 37 30 013 01 1
120	10	6 37 30 014 01 9

Further accessories

Carrying case

metal
690 x 240 x 160 mm



Order Reference 3 39 01 022 01 4

Sanding

Elastic backing pad

with flange M 14



Ø mm	Order Reference
180	6 38 06 034 01 7

Threaded flange

M 14



Order Reference 6 38 01 154 00 7

Fibre sanding discs

for backing pads, Ø 180 mm



Grain	Order Reference
24	6 37 17 024 00 0
36	6 37 17 025 00 4
50	6 37 17 026 00 7
80	6 37 17 027 00 1
120	6 37 17 028 00 9





Angle Grinders 2000 W

WSG 20-230
FEIN HIGH-POWER MOTOR

Order Reference	7 221 08	
Type	WSG 20-230	
Input	W	2000
Output	W	1250
Speed, no load	R.P.M.	6600
Cable with plug	m	4
Net weight	kg	4,5
Grinding wheel Ø	mm	230
Elast. Backing pad Ø	mm	230
Mounting thread	M	14

Price includes:

1 wheel guard, 1 pair of flanges, 1 additional handle, 1 set of keys

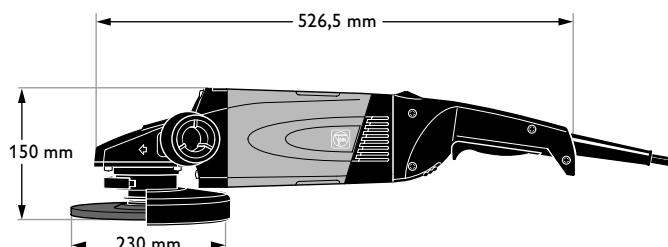

	230 mm		6600
	2000 W		4,5 kg

AT A GLANCE

Efficient angle grinder in the 2000 W class with M 14 spindle.

- HIGH-POWER-MOTOR with enormous torque for high grinding capacity.
- Self-start lock prevents uncontrolled reactivation following power supply interruption.
- Gentle start for recoil-free and safe starting.
- For all grinding, sanding, cutting and brushing applications.
- Most noiseless angle grinder in this class.
- Flattest drive head in this performance class.
- Rear handle can be rotated through 4 positions.
- Coolant air management offers optimum protection against dust.

Also available with dead-man's handle for maximum safety (7 221 08 29)

Accessories on page 135.



Roughing-down

Flexible grinding wheels
for steel, 80 m/s



Ø	Width	Order Reference
mm	mm	
180	6	6 37 10 001 00 9
180	8	6 37 10 009 00 7
230	6	6 37 10 005 00 8

for non-ferrous metal, 80 m/s

Ø	Width	Order Reference
mm	mm	
180	6	6 37 10 003 00 6
230	6	6 37 10 007 00 5

for stone, 80 m/s

Ø	Width	Order Reference
mm	mm	
180	8	6 37 10 010 00 9

Cutting

Flexible cutting wheels
for steel, 80 m/s



Ø	Width	Order Reference
mm	mm	
180	3,2	6 37 09 001 00 6
230	3,2	6 37 09 003 00 3

for stone, 80 m/s

Ø	Width	Order Reference
mm	mm	
180	3,2	6 37 09 002 00 9
230	3,2	6 37 09 004 00 1

Threaded flange

M 14, for flexible grinding/cutting wheels, circular twisted steel wire brush and fan-pattern grinding wheels



Order Reference 6 38 02 052 00 0

Inner flange



Order Reference 6 38 01 120 00 6

Protective suction hood

with guide block for cutting wheels
Ø 180 mm cutting depth 40 mm,
connection Ø 32 mm



Order Reference 9 06 04 008 01 3

with guide block for cutting wheels
Ø 230 mm cutting depth 65 mm,
connection Ø 32 mm

Order Reference 9 06 04 009 01 7

FEIN Dust Extractor, movable

for wet and dry use, with automatic switch-on facility,
incl. suction hose 3,5 m long, Ø 32 mm



Order Reference 9 20 18 223 01 3

Detailed information on "dust-free sanding" and extensive accessories for the FEIN vacuum cleaner can be found in the chapter Accessories / Vacuum cleaner

Sanding

Elastic backing pad
with flange M 14



Ø	Order Reference
mm	
180	6 38 06 034 01 7
230	6 38 06 035 01 1

Threaded flange

M 14



Order Reference 6 38 01 154 00 7

Fibre sanding discs

for backing pads, Ø 180 mm



Grain	Order Reference
24	6 37 17 024 00 0
36	6 37 17 025 00 4
50	6 37 17 026 00 7
80	6 37 17 027 00 1
120	6 37 17 028 00 9

for backing pads, Ø 230 mm

Grain	Order Reference
24	6 37 17 034 00 9
36	6 37 17 035 00 3
50	6 37 17 036 00 6
80	6 37 17 037 00 0
120	6 37 17 038 00 8

Fan-pattern sanding wheels

Ø 180 mm



Grain	VE	Order Reference
40	10	6 37 30 011 01 4
60	10	6 37 30 012 01 7
80	10	6 37 30 013 01 1
120	10	6 37 30 014 01 9

Further accessories

Carrying case
metal
690 x 240 x 160 mm



Order Reference 3 39 01 022 01 4





Quick IN



	180 mm		8500
	2000 W		4,8 kg

Angle Grinders 2000 W

WSB 20-180
FEIN HIGH-POWER MOTOR, EBS, QuickIN

Order Reference	7 221 05	
Type	WSB 20-180	
Input	W	2000
Output	W	1250
Speed, no load	R.P.M.	8500
Cable with plug	m	4
Net weight	kg	4,8
Grinding wheel Ø	mm	180
Elast. Backing pad Ø	mm	180
Mounting hole Ø	mm	22,23

Price includes:

1 wheel guard, 1 clamp for flexible grinding/cutting wheels, 1 additional handle

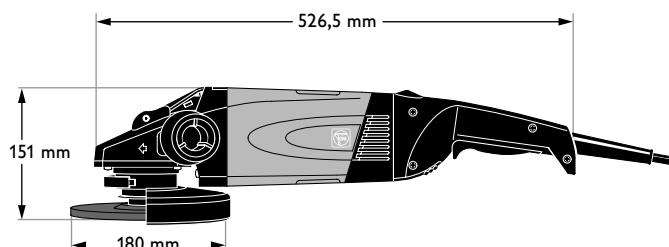

AT A GLANCE

Angle grinder with EBS is setting new scales of performance and safety in the 2000 watt class.

- Electric EBS braking system stops the discs in less than 3 seconds.
- The braking system is wear-free and maintenance-free
- HIGH-POWER-MOTOR with enormous torque for high grinding capacity.
- FEIN rapid attachment system QuickIN for fast, simple and reliable disk changes with no tools required.
- Self-start lock prevents uncontrolled reactivation following power supply interruption.
- Gentle start for recoil-free and safe starting.
- Most noiseless angle grinder in this class.
- Rear handle can be rotated through 4 positions.
- Coolant air management offers optimum protection against dust.

Also available with dead-man's handle for maximum safety
 (7 221 05 29 and 7 221 06 29)

Accessories on page 137.

Roughing-down

Flexible grinding wheels

for steel, 80 m/s



Ø	Width	Order Reference
mm	mm	
180	6	6 37 10 001 00 9
180	8	6 37 10 009 00 7

for non-ferrous metal, 80 m/s

Ø	Width	Order Reference
mm	mm	
180	6	6 37 10 003 00 6

for stone, 80 m/s

Ø	Width	Order Reference
mm	mm	
180	8	6 37 10 010 00 9

Clamping unit

for flexible grinding/cutting wheels as well as for fan-pattern wheels



Order Reference **6 38 02 183 02 5**

Cutting

Flexible cutting wheels

for steel, 80 m/s



Ø	Width	Order Reference
mm	mm	
180	3,2	6 37 09 001 00 6

for stone, 80 m/s

Ø	Width	Order Reference
mm	mm	
180	3,2	6 37 09 002 00 9

Protective suction hood

with guide block for cutting wheels Ø 180 mm cutting depth 40 mm, connection Ø 32 mm



Order Reference **9 06 04 008 01 3**

FEIN Dust Extractor, movable

for wet and dry use, with automatic switch-on facility, incl. suction hose 3,5 m long, Ø 32 mm



Order Reference **9 20 18 223 01 3**

Detailed information on "dust-free sanding" and extensive accessories for the FEIN vacuum cleaner can be found in the chapter Accessories / Vacuum cleaner

Sanding

Elastic backing pads

with clamping unit



Ø	Order Reference
mm	
180	6 38 06 174 02 8

without clamping unit

Ø	Order Reference
mm	
180	6 38 06 174 01 2

Fibre sanding discs

for backing pads, Ø 180 mm



Grain	Order Reference
24	6 37 17 024 00 0
36	6 37 17 025 00 4
50	6 37 17 026 00 7
80	6 37 17 027 00 1
120	6 37 17 028 00 9

Clamping unit

for elastic backing pads



Order Reference **6 38 02 185 02 7**

Fan-pattern sanding wheels

Ø 180 mm



Grain	VE	Order Reference
40	10	6 37 30 011 01 4
60	10	6 37 30 012 01 7
80	10	6 37 30 013 01 1
120	10	6 37 30 014 01 9

Further accessories

Carrying case

metal
690 x 240 x 160 mm

Order Reference **3 39 01 022 01 4**





230 mm $\frac{x}{min}$ 6600

2000 W 4,8 kg

Angle Grinders 2000 W

WSB 20-230
FEIN HIGH-POWER MOTOR, EBS, QuickIN

Order Reference	7 221 06	
Type	WSB 20-230	
Input	W	2000
Output	W	1250
Speed, no load	R.P.M.	6600
Cable with plug	m	4
Net weight	kg	4,8
Grinding wheel Ø	mm	230
Elast. Backing pad Ø	mm	230
Mounting hole Ø	mm	22,23

Price includes:

1 wheel guard, 1 clamp for flexible grinding/cutting wheels, 1 additional handle

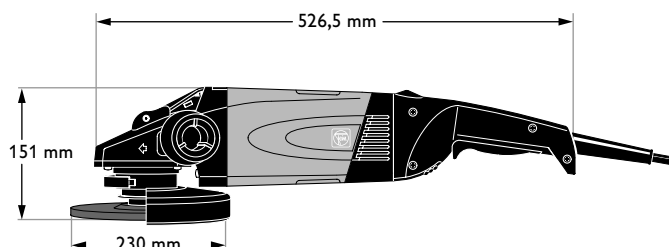

AT A GLANCE

Angle grinder with EBS is setting new scales of performance and safety in the 2000 watt class.

- Electric EBS braking system stops the discs in less than 3 seconds.
- The braking system is wear-free and maintenance-free
- HIGH-POWER-MOTOR with enormous torque for high grinding capacity.
- FEIN rapid attachment system QuickIN for fast, simple and reliable disk changes with no tools required.
- Self-start lock prevents uncontrolled reactivation following power supply interruption.
- Gentle start for recoil-free and safe starting.
- Most noiseless angle grinder in this class.
- Rear handle can be rotated through 4 positions.
- Coolant air management offers optimum protection against dust.

Also available with dead-man's handle for maximum safety
 (7 221 07 29 and 7 221 08 29)

Accessories on page 139.



Roughing-down

Flexible grinding wheels
for steel, 80 m/s



Ø	Width	Order Reference
mm	mm	
180	6	6 37 10 001 00 9
180	8	6 37 10 009 00 7
230	6	6 37 10 005 00 8

for non-ferrous metal, 80 m/s

Ø	Width	Order Reference
mm	mm	
180	6	6 37 10 003 00 6
230	6	6 37 10 007 00 5

for stone, 80 m/s

Ø	Width	Order Reference
mm	mm	
180	8	6 37 10 010 00 9

Clamping unit

for flexible grinding/cutting wheels as well as for fan-pattern wheels



Order Reference 6 38 02 183 02 5

Cutting

Flexible cutting wheels
for steel, 80 m/s



Ø	Width	Order Reference
mm	mm	
180	3,2	6 37 09 001 00 6
230	3,2	6 37 09 003 00 3

for stone, 80 m/s

Ø	Width	Order Reference
mm	mm	
180	3,2	6 37 09 002 00 9
230	3,2	6 37 09 004 00 1

Protective suction hood

with guide block for cutting wheels
Ø 180 mm cutting depth 40 mm,
connection Ø 32 mm



Order Reference 9 06 04 008 01 3

with guide block for cutting wheels
Ø 230 mm cutting depth 65 mm,
connection Ø 32 mm

Order Reference 9 06 04 009 01 7

FEIN Dust Extractor, movable

for wet and dry use, with automatic switch-on facility,
incl. suction hose 3,5 m long, Ø 32 mm



Order Reference 9 20 18 223 01 3

Detailed information on "dust-free sanding" and extensive accessories for the FEIN vacuum cleaner can be found in the chapter Accessories / Vacuum cleaner

Sanding

Elastic backing pads
with clamping unit



Ø	Order Reference
mm	
180	6 38 06 174 02 8
230	6 38 06 175 02 2

without clamping unit

Ø	Order Reference
mm	
180	6 38 06 174 01 2
230	6 38 06 175 01 6

Fibre sanding discs

for backing pads, Ø 180 mm



Grain	Order Reference
24	6 37 17 024 00 0
36	6 37 17 025 00 4
50	6 37 17 026 00 7
80	6 37 17 027 00 1
120	6 37 17 028 00 9

for backing pads, Ø 230 mm

Grain	Order Reference
24	6 37 17 034 00 9
36	6 37 17 035 00 3
50	6 37 17 036 00 6
80	6 37 17 037 00 0
120	6 37 17 038 00 8

Clamping unit

for elastic backing pads



Order Reference 6 38 02 185 02 7

Fan-pattern sanding wheels

Ø 180 mm



Grain	VE	Order Reference
40	10	6 37 30 011 01 4
60	10	6 37 30 012 01 7
80	10	6 37 30 013 01 1
120	10	6 37 30 014 01 9

Further accessories

Carrying case

metal
690 x 240 x 160 mm



Order Reference 3 39 01 022 01 4





Quick IN



180 mm $\frac{x}{min}$ 8500
 2500 W 5,4 kg

Angle Grinders 2500 W

WSB 25-180 X
FEIN HIGH-POWER MOTOR, EBS, QuickIN

Order Reference	7 221 10	
Type	WSB 25-180 X	
Input	W	2500
Output	W	1700
Speed, no load	R.P.M.	8500
Cable with plug	m	4
Net weight	kg	5,4
Grinding wheel Ø	mm	180
Elast. Backing pad Ø	mm	180
Mounting hole Ø	mm	22,23

Price includes:

1 wheel guard, 1 clamp for flexible grinding/cutting wheels, 1 additional handle

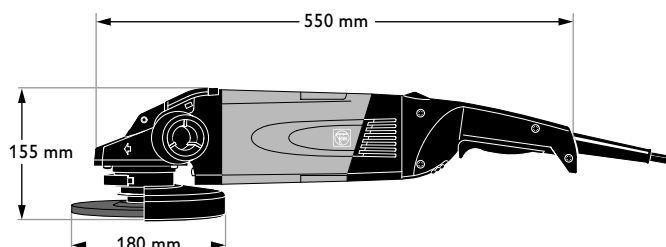

AT A GLANCE

Angle grinder with EBS, setting new standards for safety in the premium class.

- Electric EBS braking system stops the discs in less than 3 seconds.
- The braking system is wear-free and maintenance-free
- HIGH-POWER-MOTOR with enormous torque for high grinding capacity.
- FEIN rapid attachment system QuickIN for fast, simple and reliable disk changes with no tools required.
- Self-start lock prevents uncontrolled reactivation following power supply interruption.
- Gentle start for recoil-free and safe starting.
- Most noiseless angle grinder in this class.
- Rear handle can be rotated through 4 positions.
- Coolant air management offers optimum protection against dust.

Also available with dead-man's handle for maximum safety (7 221 10 29).

Accessories on page 141.

Roughing-down

Flexible grinding wheels

for steel, 80 m/s



Ø mm	Width mm	Order Reference
180	6	6 37 10 001 00 9
180	8	6 37 10 009 00 7

for non-ferrous metal, 80 m/s

Ø mm	Width mm	Order Reference
180	6	6 37 10 003 00 6

for stone, 80 m/s

Ø mm	Width mm	Order Reference
180	8	6 37 10 010 00 9

Clamping unit

for flexible grinding/cutting wheels as well as for fan-pattern wheels



Order Reference **6 38 02 183 02 5**

Cutting

Flexible cutting wheels

for steel, 80 m/s



Ø mm	Width mm	Order Reference
180	3,2	6 37 09 001 00 6

for stone, 80 m/s

Ø mm	Width mm	Order Reference
180	3,2	6 37 09 002 00 9

Protective suction hood

with guide block for cutting wheels
Ø 180 mm cutting depth 40 mm,
connection Ø 32 mm

Order Reference **9 06 04 008 01 3**

FEIN Dust Extractor, movable

for wet and dry use, with automatic
switch-on facility,
incl. suction hose 3,5 m long, Ø 32 mm

Order Reference **9 20 18 223 01 3**

Detailed information on "dust-free sanding" and extensive accessories for the FEIN vacuum cleaner can be found in the chapter Accessories / Vacuum cleaner

Sanding

Elastic backing pads

with clamping unit



Ø mm	Order Reference
180	6 38 06 174 02 8

without clamping unit

Ø mm	Order Reference
180	6 38 06 174 01 2

Fibre sanding discs

for backing pads, Ø 180 mm



Grain	Order Reference
24	6 37 17 024 00 0
36	6 37 17 025 00 4
50	6 37 17 026 00 7
80	6 37 17 027 00 1
120	6 37 17 028 00 9

Clamping unit

for elastic backing pads



Order Reference **6 38 02 185 02 7**

Fan-pattern sanding wheels

Ø 180 mm



Grain	VE	Order Reference
40	10	6 37 30 011 01 4
60	10	6 37 30 012 01 7
80	10	6 37 30 013 01 1
120	10	6 37 30 014 01 9

Further accessories

Carrying case

metal
690 x 240 x 160 mm

Order Reference **3 39 01 022 01 4**



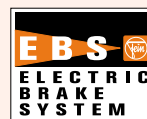

Angle Grinders 2500 W

WSB 25-230 X
FEIN HIGH-POWER MOTOR, EBS, QuickIN

Order Reference		7 221 11
Type		WSB 25-230 X
Input	W	2500
Output	W	1700
Speed, no load	R.P.M.	6600
Cable with plug	m	4
Net weight	kg	5,4
Grinding wheel Ø	mm	230
Elast. Backing pad Ø	mm	230
Mounting hole Ø	mm	22,23

Price includes:

1 wheel guard, 1 clamp for flexible grinding/cutting wheels, 1 additional handle

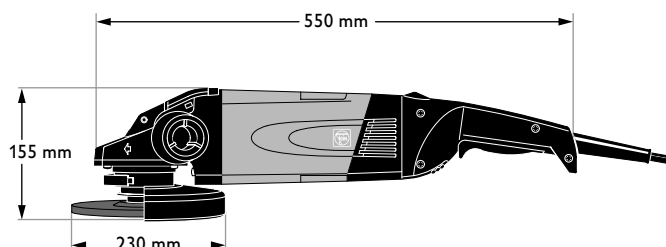

	230 mm		6600
	2500 W		5,4 kg

AT A GLANCE

Angle grinder with EBS, setting new standards for safety in the premium class.

- Electric EBS braking system stops the discs in less than 3 seconds.
- The braking system is wear-free and maintenance-free
- HIGH-POWER-MOTOR with enormous torque for high grinding capacity.
- FEIN rapid attachment system QuickIN for fast, simple and reliable disk changes with no tools required.
- Self-start lock prevents uncontrolled reactivation following power supply interruption.
- Gentle start for recoil-free and safe starting.
- Most noiseless angle grinder in this class.
- Rear handle can be rotated through 4 positions.
- Coolant air management offers optimum protection against dust.

Also available with dead-man's handle for maximum safety (7 221 11 29).

Accessories on page 143.

Roughing-down

Flexible grinding wheels
for steel, 80 m/s



Ø	Width	Order Reference
mm	mm	
180	6	6 37 10 001 00 9
180	8	6 37 10 009 00 7
230	6	6 37 10 005 00 8

for non-ferrous metal, 80 m/s

Ø	Width	Order Reference
mm	mm	
180	6	6 37 10 003 00 6
230	6	6 37 10 007 00 5

for stone, 80 m/s

Ø	Width	Order Reference
mm	mm	
180	8	6 37 10 010 00 9

Clamping unit

for flexible grinding/cutting wheels as well as for fan-pattern wheels



Order Reference 6 38 02 183 02 5

Cutting

Flexible cutting wheels
for steel, 80 m/s



Ø	Width	Order Reference
mm	mm	
180	3,2	6 37 09 001 00 6
230	3,2	6 37 09 003 00 3

for stone, 80 m/s

Ø	Width	Order Reference
mm	mm	
180	3,2	6 37 09 002 00 9
230	3,2	6 37 09 004 00 1

Protective suction hood

with guide block for cutting wheels
Ø 180 mm cutting depth 40 mm,
connection Ø 32 mm



Order Reference 9 06 04 008 01 3

with guide block for cutting wheels
Ø 230 mm, cutting depth 65 mm,
connection Ø 32 mm

Order Reference 9 06 04 009 01 7

FEIN Dust Extractor, movable

for wet and dry use, with automatic
switch-on facility,
incl. suction hose 3,5 m long, Ø 32 mm



Order Reference 9 20 18 223 01 3

Detailed information on "dust-free sanding" and extensive accessories for the FEIN vacuum cleaner can be found in the chapter Accessories / Vacuum cleaner

Sanding

Elastic backing pads
with clamping unit



Ø	Order Reference
mm	
180	6 38 06 174 02 8
230	6 38 06 175 02 2

without clamping unit

Ø	Order Reference
mm	
180	6 38 06 174 01 2
230	6 38 06 175 01 6

Fibre sanding discs

for backing pads, Ø 180 mm



Grain	Order Reference
24	6 37 17 024 00 0
36	6 37 17 025 00 4
50	6 37 17 026 00 7
80	6 37 17 027 00 1
120	6 37 17 028 00 9

for backing pads, Ø 230 mm

Grain	Order Reference
24	6 37 17 034 00 9
36	6 37 17 035 00 3
50	6 37 17 036 00 6
80	6 37 17 037 00 0
120	6 37 17 038 00 8

Clamping unit

for elastic backing pads



Order Reference 6 38 02 185 02 7

Fan-pattern sanding wheels

Ø 180 mm



Grain	VE	Order Reference
40	10	6 37 30 011 01 4
60	10	6 37 30 012 01 7
80	10	6 37 30 013 01 1
120	10	6 37 30 014 01 9

Further accessories

Carrying case

metal
690 x 240 x 160 mm



Order Reference 3 39 01 022 01 4





Construction cutter





MF 12-180
FEIN HIGH-POWER MOTOR

Order Reference		7 238 12
Type		MF 12-180
Input	W	1200
Output	W	750
Speed, no load	R.P.M.	7000
Cable with plug	m	4
Net weight	kg	4,1
Diamond wheel Ø	mm	180
Cutting depth	mm	0 - 50

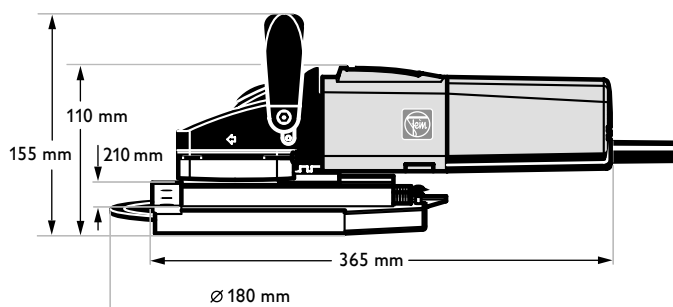
Price includes:

1 metal tool case, 1 diamond wheel, Ø 180 mm



	180 mm		7000
	1200 W		4,1 kg

AT A GLANCE

Extremely powerful and robust construction cutter for dismantling old windows.

- HIGH-POWER-MOTOR for unmatched performance and durability.
- Dust-free operation with closed suction container.
- Stable grip ensures secure handling.
- Precise cuts without damaging the walls.
- Cut passes just 2 mm along the old window frame.
- Cutting depth can be precisely set by the depth stop.
- Top-quality diamond wheel.
- Ideal supplement: FEIN SUPERCUT for cutting window frames.

Accessories on page 145.



Diamond wheel

Ø 180 mm, special retainer
for MF 12-180.

Order Reference 6 35 02 146 01 1









Angle Polisher 1200 W

WPO 12-27 E
FEIN HIGH-POWER MOTOR

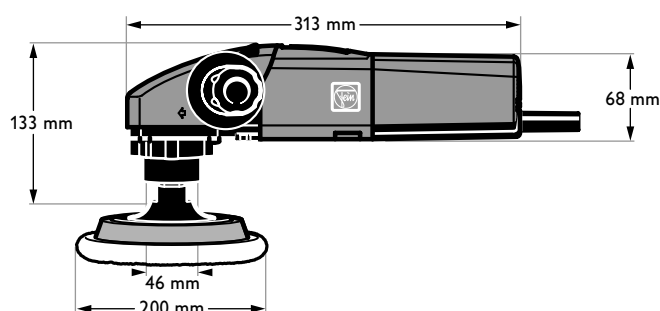
Order Reference	7 220 91 00	
Type	WPO 12-27 E	
Input	W	1200
Output	W	750
Speed, no load	R.P.M.	900-2700
Cable with plug	m	4
Net weight	kg	2,3
Polishing disc Ø	mm	250
Mounting thread	M	14

Price includes:
1 additional handle



 250 mm	 900-2700
 1200 W	 2,3 kg

AT A GLANCE

Angle polisher for final sanding, fine brushing, matting and polishing.

- HIGH-POWER-MOTOR for unmatched performance and durability.
- Self-start lock prevents uncontrolled reactivation following power supply interruption.
- Variable electronic speed control for optimum application.
- With work arbor also suitable for use as a professional longitudinal satin-finisher.
- Maximum speed stability irrespective of the load, throughout the entire setting range.
- Ergonomic grip-hood for fatigue-free and comfortable working.
- Spindle brake for quick tool changes.
- Accessory sets available for a board range of application.
- Gentle start for recoil-free and safe starting.
- Used in conjunction with the angle grinder WSG 12-70 E, makes an ideal surface finishing treatment combination.

Accessories on pages 148-150.



■ Profi-Set stainless steel

Professional set for stainless steel
FEIN HIGH-POWER MOTOR

Order Reference	7 220 91 50	
Type	Professional set for stainless steel	
Input	W	1200
Output	W	750
Speed, no load	R.P.M.	900-2700
Cable with plug	m	4
Net weight	kg	2,3
Polishing disc Ø	mm	250
Mounting thread		M 14

Price includes:

1 FEIN Angle Polisher WPO 12-27 E, 1 metal tool case, 1 additional handle, 1 holder, rotating, safety guard, 1 work arbor for rollers, 1 elastic sanding roller (100 x 100 mm, grain 60), 1 lamella fleece cylinder (100 x 100 mm, grain 180), 1 sanding fleece with folds (30 x 150 mm, M14), 1 work arbor 15-50 mm, 10 sanding fleeces with velcro (Ø 115 mm, fine), 1 supporting plate with velcro adhesion section (Ø 115 mm, M14), 1 stainless steel INOX-top round brush (Ø115 mm, M14), 2 keys

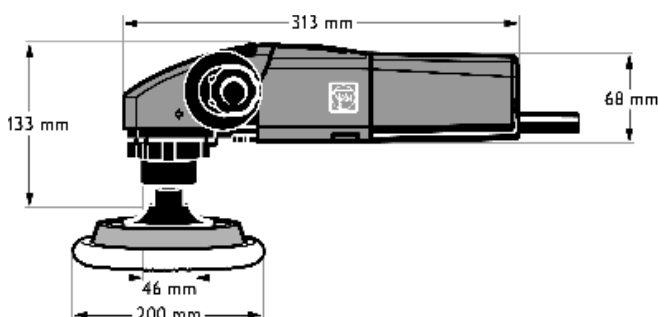

	250 mm		900-2700
	1200 W		2,3 kg

AT A GLANCE

Brilliant results, every time.

- HIGH-POWER-MOTOR for unmatched performance and durability.
- Variable electronic speed control for optimum application.
- With work arbor also suitable for use as a professional longitudinal satin-finisher.
- Maximum speed stability irrespective of the load, throughout the entire setting range.
- Ergonomic grip-hood for fatigue-free and comfortable working.
- Self-start lock prevents uncontrolled reactivation following power supply interruption.
- Spindle brake for quick tool changes.
- Accessory sets available for a board range of application.

Accessories on pages 148-150.

Basic set

consisting of: 1 elastic sanding cylinder, 100 x 100 mm, grain 60, 1 lamb's fleece cylinder, 100 x 100 mm, grain 180; 1 sanding fleece, waved, 30 x 150 mm, M14; 1 work arbor; 10 sanding fleeces with Velcro, Ø 115 mm, fine; 1 supporting place with Velcro attachment, Ø 115 mm, M14; 1 INOX round brush, Ø 115 mm, M14; 2 keys



Order Reference 6 37 21 006 02 8

Pipe set

consisting of: 1 sanding strip; 10 sanding strips 600 x 30 mm, grain 60; 10 sanding strips 600 x 30 mm, grain 120; 1 fleece strip 600 x 30 mm, medium; 1 fleece strip 600 x 30 mm, fine; 1 adhesive strip for sanding strips, counterweights for sanding strip roll.



Order Reference 6 38 06 181 02 2

Matting set

1 lamella sanding disc, 150 x 50 mm, coarse, K 40 1 lamella sanding disc, 150 x 50 mm, medium, K 60; 1 lamella sanding disc, 150 x 50 mm, fine, K 80; 1 work arbor 15-50 mm; 2 keys.



Order Reference 6 37 21 003 02 3

Polishing-set

Consisting of: 1 Polishing ring, 150 x 30 mm, sisal/cloth; 2 polishing rings, 150 x 15 mm, cloth firm; 2 polishing rings, 150 x 15 mm, cloth soft; 1 brush paste for sisal/cloth, yellow; 1 prepolishing paste for cloth firm, orange; 1 colouring paste for cloth soft, white; 1 work arbor, 15-35 mm, 2 keys.



Order Reference 6 37 23 011 02 0

Basic equipment accessories

Elastic sanding cylinder

100 x 100 mm



Grain	Type	Order Reference
60	coarse	6 37 21 006 01 2
180	fine	6 37 21 007 01 6

Lamella fleece cylinder

100 x 100 mm



Grain	Type	Order Reference
100	medium	6 37 21 008 01 4
180	fine	6 37 21 009 01 8
280	very fine	6 37 21 010 01 0

Sanding fleece

with corrugated folds, width approx. 30 mm, bore hole 14 mm, for light finishing work, derusting, polishing and decorative work



Ø mm	Order Reference
150	6 37 23 021 01 3
200	6 37 23 022 01 6

Ø 115 mm, stable, with hook and loop quick-attachment, for use with backing pad 6 38 06 172 01 0



Grain	VE	Order Reference
coarse	10	6 37 32 001 01 8
medium	10	6 37 32 002 01 1
fine	10	6 37 32 003 01 5

Backing pad

with hook and loop fastener, for working with abrasive fleece, M 14



Ø mm	Order Reference
115	6 38 06 172 01 0

INOX round brush

115 mm, M14



Order Reference 6 37 22 049 01 8

Pipe processing

Sanding strip roll

100 x 70 mm



Order Reference 6 38 06 181 01 6

Sanding strips

600 x 30 mm

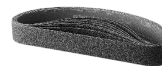

Grain	VE	Order Reference
60	10	6 37 14 044 01 0
120	10	6 37 14 045 01 4
240	10	6 37 14 046 01 7

Adhesive strip

for sanding strips

Order Reference 6 38 09 004 01 9

Fleece strips

600 x 30 mm



Type	Order Reference
coarse	6 37 14 047 01 1
medium	6 37 14 048 01 9
fine	6 37 14 049 01 3

Matting

Abrasive fleece wheels

Ø 150 mm, width 50 mm, bore hole 14 mm, for eliminating minor blemishes and producing a matt finish



Order Reference 6 37 21 003 01 7

for medium brush applications

Order Reference 6 37 21 004 01 5

for fine brush applications

Order Reference 6 37 21 005 01 9

Polishing

Polishing rings, Sisal, cloth

- fine finishing/brushing and levelling of non-ferrous metals following preliminary sanding with K 240-280 using polishing paste „yellow“.

- fine finishing/brushing and levelling of iron/steel and stainless steel following preliminary sanding with K 280-320 using polishing paste „yellow“.

- matt polishing/brushing of non-ferrous metals, iron/steel and stainless steel using polishing paste „yellow“.

- preliminary polishing of iron/steel and stainless steel with polishing paste „orange“. Width approx. 30 mm, bore hole 14 mm



Ø mm	Order Reference
150	6 37 23 011 01 4
200	6 37 23 012 01 7

Polishing rings, hard cloth

Width approx. 15 mm, bore hole 14 mm, for preliminary polishing and polishing of non-ferrous metals, iron/steel, stainless steel with preliminary polishing paste „orange“



Ø mm	Order Reference
150	6 37 23 013 01 1
200	6 37 23 015 01 3

Polishing rings, soft cloth

Width approx. 15 mm, bore hole 14 mm, for high-gloss polishing of non-ferrous metals, iron/steel, stainless steel and chrome with final polishing paste „white“

Ø mm	Order Reference
150	6 37 23 014 01 9
200	6 37 23 016 01 6

Polishing rings, fleece, extra soft

Width approx. 15 mm, bore hole 14 mm, for final polishing of non-ferrous metals, iron/steel, stainless steel and many plastics with final polishing paste „white“

Ø mm	Order Reference
150	6 37 23 019 01 2
200	6 37 23 020 01 4

Polishing wheels

Ø 150 mm, width 60 mm, bore 14 mm for secondary polishing, grit 16, soft, „green“



Order Reference 6 37 13 013 01 8

for delicate surfaces, grit 24, soft, „blue“

Order Reference 6 37 13 015 01 0

for fine polishing, grit 46, soft, „brown“

Order Reference 6 37 13 016 01 3

required: work arbour, order No. 6 38 03 066 02 4

Brushing paste

„yellow“, for matt polishing non-ferrous metals, iron/steel and stainless steel



Order Reference 6 37 26 001 01 8

Preliminary polishing paste

„orange“, for preliminary polishing and polishing non-ferrous metals, iron/steel and stainless steel



Order Reference 6 37 26 002 01 1

Rumbling paste

„white“, for high gloss polishing of non-ferrous metals, iron/steel, stainless steel and chrome



Order Reference 6 37 26 003 01 5

Viennese chalk

Special steel cleaning powder to remove polishing paste and finger prints, 1 kg.

Order Reference 6 37 26 007 01 4

Nettle buffer / Flannel buffer

Ø 250 mm, width 40 mm consisting of two parts for non ferrous metals, iron, steel, chrome - for prepolishing and polishing with prepolishing paste „orange“ - for high gloss polishing with final polishing paste „white“



Type	Order Reference
Nettle buffer	6 37 23 004 01 0
Flannel buffer	6 37 23 005 01 4

required: work arbour, order No. 6 38 03 066 02 4

Lambskin

with hook and loop fastening quick-attachment



Ø mm	Order Reference
125	6 37 23 008 00 0
150	6 37 23 009 00 4
200	6 37 23 010 00 6

Polishing sponge

with hook and loop fastening rapid-attachment, height 40 mm



Ø mm	Type	Order Reference
100	weich	6 37 23 024 01 8
100	hart	6 37 23 023 01 0
125	-	6 37 23 017 01 0
150	-	6 37 23 018 01 8
160	weich	6 37 23 026 01 5
160	hart	6 37 23 025 01 2

required: support plate (Ø 125 mm) 6 38 06 169 01 6
or support plate (Ø 150 mm) 6 38 06 170 01 8
or support plate (Ø 80 mm) 6 38 06 179 01 5

Backing pad

with hook and loop fastening attachment section, rubber-lined, M 14



Ø mm	Order Reference
80	6 38 06 179 01 5
125	6 38 06 169 01 6
130	6 38 06 178 01 1
150	6 38 06 170 01 8
200	6 38 06 171 01 7

Lambskin

with tensioning cord



Ø mm	Order Reference
120	6 37 23 007 00 2
170	6 37 23 003 00 3

Backing pad

for lamb's fleece with tensioning cord, rubber coated, M 14



Ø mm	Order Reference
120	6 38 06 012 00 8
170	6 38 06 030 00 4

for self-adhesive sanding sheets

Ø mm	Order Reference
80	6 38 06 180 01 7

Abrasive fleece wheel

Ø 200 mm, width 50 mm, for polishing stainless steel



Ø mm	Order Reference
200	6 37 21 001 00 1

required: work arbour, order No. 6 38 03 066 02 4

Fine brushing

Nylon barrel brush

Ø 125 mm, grain 46, M 14, for light deburring and removal of rust, scale and paint. Excellent for restoration applications.



Order Reference 6 37 22 048 01 4



Selection table polishing with hook and loop fastening rapid-attachment

	Backing pad Ø 80mm	Ø 125 mm	Ø 130 mm	Ø 150 mm	Ø 200 mm
lambskin					
Ø 125 mm	X				
Ø 150 mm				X	
Ø 200 mm					X
polishing sponge					
Ø 100 mm	X				
Ø 125 mm		X			
Ø 150 mm				X	
Ø 160 mm			X		

Further accessories

Holder

for side handle, 360° rotatable



Order Reference 3 30 21 102 02 2

Wheel arbor

for Politex surface conditioning wheels,
clamp range 100 mm, tool mounting Ø 19 mm



Order Reference 6 38 03 067 02 8

with clamping flange M 14, for polishing rings, clamping range 15-35 mm



Order Reference 6 38 03 027 03 8

with clamping flange M 14, for abrasive fleece wheels and polishing wheels
clamping range 15-50 mm



Order Reference 6 38 03 066 02 4

Spanner 6 29 04 003 00 0 (SVV 19/20) and face spanner 6 29 10 022 00 2 required.

Safety guard

as hand guard



Order Reference 3 02 29 216 00 5

Carrying case

metal

390 x 210 x 140 mm



Order Reference 3 39 01 045 01 8

Intensive cleaner

ml	Order Reference
500	6 37 26 004 01 3

Polishing liquid

ml	Order Reference
500	6 37 26 005 01 7

Sealing

ml	Order Reference
400	6 37 26 006 01 0

Polishing-set

Order Reference 6 38 06 178 02 7



■ Pipe sander 1200 W

RS 12-70 E
FEIN HIGH-POWER MOTOR

Order Reference		7 221 13 50
Type		RS 12-70 E
Input	W	1200
Output	W	750
Speed, no load	R.P.M.	2700-700
Cutting speed	m/sec	22
Minimum wall clearance	mm	50
Net weight	kg	3,8
Cable with plug	m	4
Pipes up to Ø	mm	8 - 80

2700-700 3,8 kg

1200 W

AT A GLANCE

Pipe sander for sanding and polishing stainless steel pipes.

- Most powerful pipe sander commercially available.
- HIGH-POWER-MOTOR for unmatched performance and durability.
- Extremely high abrasion performance.
- Cutting speed up to 22 m/s.
- Sanding and polishing as quick as possible.
- Usage ranges from rough grinding to mirror polish.
- Sanding of pipe arcs in just two passes.
- Tracking stability by precise belt guides.
- Tool-free belt change.
- Self-start lock prevents uncontrolled reactivation following power supply interruption.

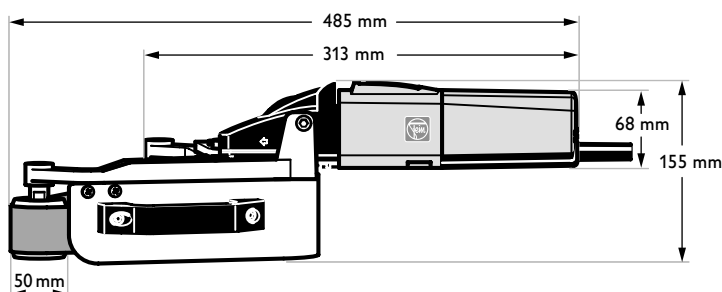

Accessories on page 153.



FEIN professional set pipe sander

FEIN professional set pipe sander
FEIN HIGH-POWER MOTOR

Order Reference	7 221 13 51	
Type	FEIN professional set pipe sander	
Input	W	1200
Output	W	750
Speed, no load	R.P.M.	2700-700
Cutting speed	m/sec	22
Minimum wall clearance	mm	50
Net weight	kg	3,8
Cable with plug	m	4
Pipes up to Ø	mm	8 - 80

Price includes:

2 x 10 pcs. polishing belts, 20x815 mm P120/P180, 2 x 10 pcs. polishing belts, 40x815 mm P120/P180, 5 fleece belts 20 x 820 mm very fine, 1 metal tool case

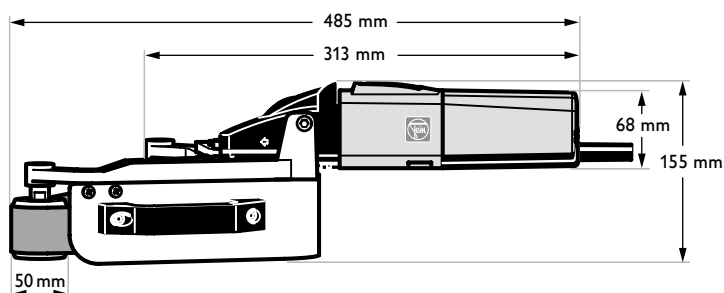

2700-7000 3,8 kg

1200 W

AT A GLANCE

FEIN professional set RS 12-70 E with basic equipment.

- Most powerful pipe sander commercially available.
- HIGH-POWER-MOTOR for unmatched performance and durability.
- Extremely high abrasion performance.
- Cutting speed up to 22 m/s.
- Sanding and polishing as quick as possible.
- Usage ranges from rough grinding to mirror polish.
- Sanding of pipe arcs in just two passes.
- Tracking stability by precise belt guides.
- Tool-free belt change.
- Self-start lock prevents uncontrolled reactivation following power supply interruption.

Accessories on page 153.

Basic set

2 x 10 sanding strips, 20 x 815 mm, P 120/P180, 2 x 10 sanding strips, 40 x 815 mm, P 120/P180, 5 fleece belts, 20 x 820 mm, very fine 280



Order Reference 6 37 14 050 02 1

Polishing-set

2 x 10 sanding strips, 20 x 815 mm, P320/P400, 1 x 3 polishing belts, 20 x 815 mm, 1 pre-polishing cream, red (200 ml), 1 tube colouring paste, white (200 ml)



Order Reference 6 37 14 052 02 3

Sanding strips

20 x 815 mm



Grain	VE	Order Reference
120	10	6 37 14 050 01 5
180	10	6 37 14 051 01 4
320	10	6 37 14 052 01 7
400	10	6 37 14 053 01 1

Fleece strips

20 x 815 mm



	VE	Order Reference
80	5	6 37 14 056 01 6
120	5	6 37 14 057 01 0
280	5	6 37 14 058 01 8

Polishing belts

20 x 815 mm (pack of 3)



Order Reference 6 37 26 010 01 8

Pre-polishing paste

red



Order Reference 6 37 26 008 01 2

Colouring paste

white



Order Reference 6 37 26 009 01 6

Viennese chalk

Special steel cleaning powder to remove polishing paste and finger prints, 1 kg.

Order Reference 6 37 26 007 01 4

Guide pulleys

for confined spaces

Order Reference 3 13 35 017 01 1

Metal tool case

unfilled

Order Reference 3 39 01 022 03 6





■ Straight Grinders.

The FEIN die grinders are used mainly for grinding and polishing counter-sinks, touching up cutting and stamping tools, finishing small casts, smoothing out welded seams, and for fine detailed work.

All the tools are characterised by their typical FEIN robustness, ease of handling and performance.

When used as a small contact belt grinder, the die grinders provide a particularly efficient and straight-forward solution for finishing surfaces and welded seams. For such applications the grinding wheel is replaced by a sanding belt, which is driven by a contact plate via an idler. The belt run can be adjusted with extreme precision to suit each individual task.

Simply fit the appropriate special belt to suit the material (metal/plastic) and the sanding type. The sanding arm can be swung around the shaft into any desired position.



Die Grinder, 4500/min

AHSI 636 c

Order Reference		7 223 02
Type		AHSI 636 c
Input	W	280
Output	W	150
Speed, no load	R.P.M.	4500
Cable with plug	m	3
Net weight	kg	1,5
Grinding wheel for min. 30 m/s, max Ø x width	mm	50 x 10
Capacity in steel Ø	mm	4
Thread of spindle	UNF	1/2"-20

Price includes:

1 3- jaw chuck up to Ø 10 mm, 1 neck sleeve, 1 set of keys

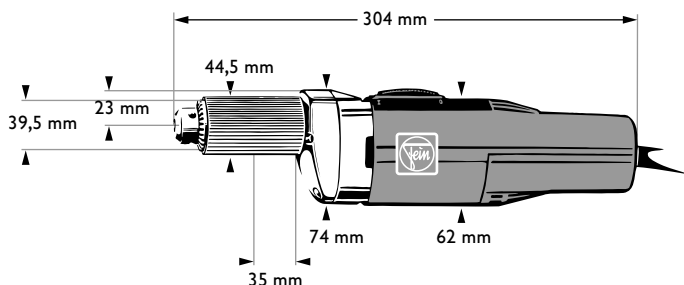

	50 mm		4500
	280 W		1,5 kg

AT A GLANCE

Universal die grinder for brushing, sanding, polishing and drilling.

- Compact design for easy and safe operation.
- Favourable corner width for working in difficult-to-reach areas.
- Can also be used as a drill.

Accessories on page 156.

Grinding wheelNK
60, 50 x 10 x 13 mm**Order Reference 6 37 01 006 00 1****Carrying case**metal
390 x 240 x 110 mm**Order Reference 3 39 01 067 01 3****Wheel arbor**

for grinding wheel

**Order Reference 6 38 03 058 01 1****Polishing felt**75 x 40 mm,
with 6 mm shank**Order Reference 6 37 18 001 00 4****Steel wire brush**60 x 10 mm,
rubber bonded with 6 mm shank**Order Reference 6 37 22 023 00 0**

70 x 9 mm, with 6 mm shank

Order Reference 6 37 22 022 00 6



Die Grinder, 45 000/min

MSh 635

Order Reference	7 223 12
Type	MSh 635
Input	W 350
Output	W 220
Speed, no load	R.P.M. 45 000
Cable with plug	m 2,5
Net weight	kg 1

Grinding wheel for min. 50 m/s,
max Ø x width mm 13 x ..1)

Price includes:

1 collet Ø 3 mm, 1 key, 1 retaining pin, 1 adjustable handle, 1 plastic carrying case

	13 mm		45 000
	350 W		1 kg

AT A GLANCE

High-speed die grinder for grinding and milling.

- Ideal for use in the machine tool, model and mould-making industry.
- Quiet movement for precision working.
- Ergonomic grip for excellent handling.
- Can also be used as a stationary machine.

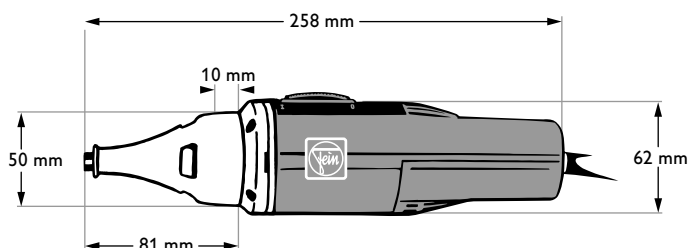

1) Admissible width depending on open length of shaft according to DIN 69 170. Please observe the indicators on the grinding wheel label.

Accessories on page 159.



Die Grinder, 28 000/min

MSh 636-1

Order Reference	7 223 03
Type	MSh 636-1
Input	W 280
Output	W 150
Speed, no load	R.P.M. 28 000
Cable with plug	m 4
Net weight	kg 1,5

Grinding wheel for min. 30 m/s, max Ø x width	mm 20 x .. ¹⁾
Grinding wheel for min. 50 m/s, max Ø x width	mm 20 x .. ¹⁾

Price includes:

1 collet Ø 6 mm, 1 set of keys

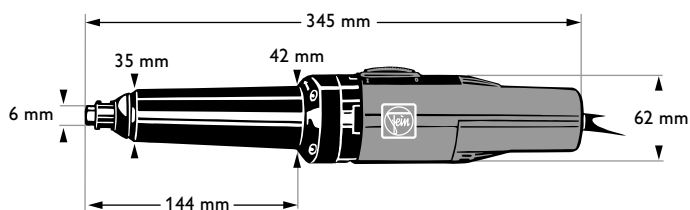

20 mm	28 000
280 W	1,5 kg

AT A GLANCE

Universal die grinder for applications in difficult-to-reach areas.

- Narrow neck for interior applications.
- Safe machine control.
- Spindle with multiple bearings for quiet operation.

¹⁾ Admissible width depending on open length of shaft according to DIN 69 170. Please observe the indicators on the grinding wheel label.

Accessories on page 159.

for MSh 635

Collets



Ø mm	Order Reference
3	6 32 07 097 00 0
6	6 32 07 103 00 9
1/8"	6 32 07 111 00 1

Collet chuck Ø 6 mm, suitable only for inserting HM, HSS, and diamond tooth and coated milling cutters.

for MSh 636-1

Support



Order Reference 3 18 01 010 01 2

Hard metal cutters

Tooth number 3 for the shaping of steel



Shaft Ø mm	Dimensions Ø x L	Order Reference
6	6 x 18	6 35 07 001 00 0
8	12 x 25	6 35 07 002 00 3



Shaft Ø mm	Dimensions Ø x L	Order Reference
8	12x25	6 35 07 003 00 7



Shaft Ø mm	Dimensions Ø x L	Order Reference
6	6x18	6 35 07 004 00 5
8	12x30	6 35 07 005 00 9



Shaft Ø mm	Dimensions Ø x L	Order Reference
6	8	6 35 07 006 00 2

Collets

Depth 30 mm



Capacity	Order Reference
3	6 32 07 087 00 1
6	6 32 07 059 00 6
8	6 32 07 069 00 5
1/8"	6 32 07 089 00 3
1/4"	6 32 07 088 00 9

General accessory

Carrying case

metal
390 x 240 x 110 mm



Order Reference 3 39 01 067 01 3





Die Grinder, 26 500/min

MSh 648





MSh 648
FEIN electronic

Order Reference		7 223 05 00	7 223 05 95
Type		MSh 648	MSh 648
Input	W	650	650
Output	W	420	420
Speed, no load	R.P.M.	23 000	8500 - 26 500
Cable with plug	m	4	4
Net weight	kg	3,1	3,1
Grinding wheel for min. 50 m/s, max Ø x width	mm	36 x ..1)	36 x ..1)
Grinding wheel for min. 80 m/s, max Ø x width	mm	50 x 10	50 x 10

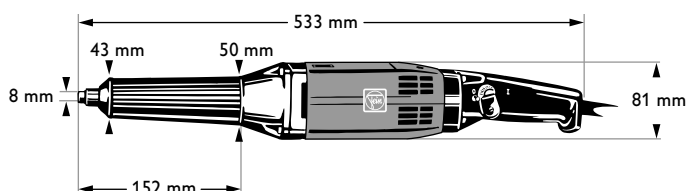
Price includes:

1 collet Ø 8 mm, 1 set of keys



 50 mm	 8500-26500
 650 W	 3,1 kg

AT A GLANCE

High-performance die grinder.

- Suitable for grinding disks and carbide burrs.
- Spindle with multiple bearings for quiet operation.
- High performance motor with impressive power.

for MSh 648 :

- Due to speed control it is excellently suited for trating pure steel.

1) Admissable width depending on open length of shaft according to DIN 69 170. Please observe the indicators on the grinding wheel label.

Accessories on page 162.



Die Grinder, 5200/min

MShy 648 Z

Order Reference	7 223 06
Type	MShy 648 Z
Input	W 650
Output	W 420
Speed, no load	R.P.M. 5200
Cable with plug	m 4
Net weight	kg 3,1

Grinding wheel for min. 50 m/s, max Ø x width	mm	50 x ..1)
Grinding wheel for min. 80 m/s, max Ø x width	mm	50 x 10

Price includes:
1 collet Ø 8 mm, 1 set of keys

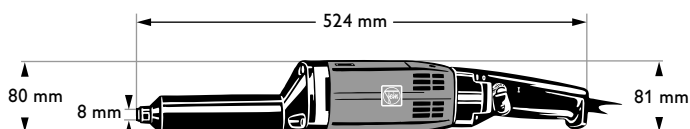

50 mm

5200

650 W

3,1 kg

AT A GLANCE

Robust die grinder.

- High performance motor with impressive power.
- Spindle with multiple bearings for quiet operation.
- Speed suitable for grinding and polishing works.
- Also suitable for working stainless steel.

¹⁾ Admissable width depending on open length of shaft according to DIN 69 170. Please observe the indicators on the grinding wheel label.

Accessories on page 162.

Grinding wheel

36 x 10 x 13 mm



Type	Order Reference
NK 24 (A)	6 37 07 008 00 2
SC 24 (C)	6 37 07 009 00 6

Wheel arbor

for grinding wheel



Order Reference 6 38 03 058 01 1

Collets

Depth 30 mm



Capacity	Order Reference
3	6 32 07 087 00 1
6	6 32 07 059 00 6
8	6 32 07 069 00 5
1/8"	6 32 07 089 00 3
1/4"	6 32 07 088 00 9

Carrying case

metal
700 x 180 x 100 mm



Order Reference 3 39 01 021 01 1

**for MSh 648,
MShe 648**

Grinding wheel

36 x 10 x 13 mm

Type	Order Reference
NK 24 (A)	6 37 04 004 00 6

Hard metal cutters

Tooth number 3 for the shaping of steel



Shaft Ø mm	Dimensions Ø x L	Order Reference
6	6 x 18	6 35 07 001 00 0
8	12 x 25	6 35 07 002 00 3



Shaft Ø mm	Dimensions Ø x L	Order Reference
8	12x25	6 35 07 003 00 7



Shaft Ø mm	Dimensions Ø x L	Order Reference
6	6x18	6 35 07 004 00 5
8	12x30	6 35 07 005 00 9



Shaft Ø mm	Dimensions Ø x L	Order Reference
6	8	6 35 07 006 00 2

for MShy 648 Z

Polishing wheel

75 x 19 x 12,7 mm Type SC 150 (C)



Order Reference 6 37 13 005 00 2

Wheel arbor

for polishing wheels

Order Reference 6 38 03 054 01 2



■ Straight Grinder, 8300/min

MShy 649

Order Reference	7 224 01
Type	MShy 649
Input	W 750
Output	W 480
Speed, no load	R.P.M. 8300
Cable with plug	m 5
Net weight	kg 3,6

Grinding wheel for min. 50 m/s
 max Ø x width mm 100 x 32/28

Price includes:

1 wheel guard, 1 pair of flanges, 1 set of keys

	100 mm		8300
	750 W		3,6 kg

AT A GLANCE

Straight grinder with flange wheel clamping.

- High performance motor with impressive power.
- For grinding and sanding applications.
- Suitable for use with flap wheels.

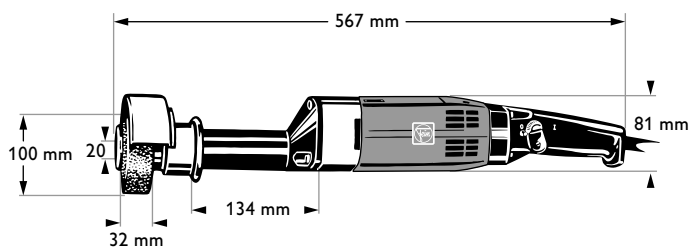

Accessories on page 165.



■ Straight Grinder, 6900/min

MShy 664





Order Reference	7 224 03
Type	MShy 664
Input	W 1400
Output	W 920
Speed, no load	R.P.M. 6900
Cable with plug	m 4
Net weight	kg 4,5

Grinding wheel for min. 50 m/s
 max Ø x width mm 125 x 32/26

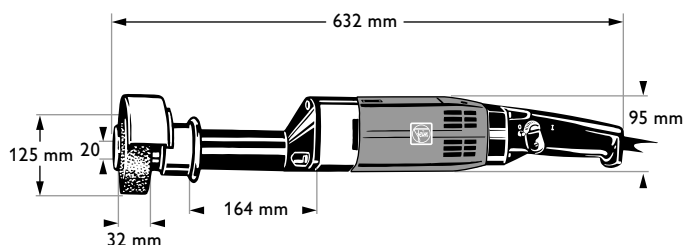
Price includes:

1 wheel guard, 1 pair of flanges, 1 set of keys



 125 mm	 6900
 1400 W	 4,5 kg

AT A GLANCE

Robust straight grinder with flange wheel clamping.

- High performance motor with impressive power.
- For rough grinding, sanding and polishing applications.
- With the corresponding accessories can also be used as a belt sander.

for MShy 649

Grinding wheel
100 x 32/28 x 20 mm



Type	Order Reference
NK 24 (A)	6 37 05 003 00 9
SC 24 (A)	6 37 05 004 00 7

Abrasive fleece wheel
100 x 30 x 20 mm



Grain	Order Reference
80	6 37 21 002 00 4

Carrying case
metal 700 x 180 x 100 mm



Order Reference 3 39 01 021 01 1

for MShy 664

Grinding wheel
125 x 32/26 x 20 mm



Type	Order Reference
NK 24 (A)	6 37 05 012 00 4
SC 24 (A)	6 37 05 013 00 8

Small belt sander
36 m/s, width 50 mm, consisting of sanding arm and contact disc



Order Reference 6 38 10 011 01 6
required: Contact disc 6 38 06 077 00 5

Contact disc
Ø 100 mm, 50 mm width



Order Reference 6 38 06 077 00 5

Retaining pin

Order Reference 6 29 13 004 00 0

Linen sanding belt

for small belt sanders length 800 mm, width 50 mm for grinding



Grain	Order Reference
40	6 37 14 011 00 9
60	6 37 14 012 00 2

for finishing

Grain	Order Reference
80	6 37 14 013 00 6
120	6 37 14 014 00 4
180	6 37 14 015 00 8
220	6 37 14 026 00 0
320	6 37 14 027 00 4

Small belt sander

Width 30 mm, consisting of sanding arm, contact disc, clamping flanges and retaining pin

Order Reference 6 38 10 025 02 0

Linen sanding belt

for small belt sanding Length 800 mm, width 30 mm for grinding

Grain	Order Reference
40	6 37 14 004 00 5
60	6 37 14 005 00 9

for finishing

Grain	Order Reference
80	6 37 14 006 00 2
120	6 37 14 007 00 6
180	6 37 14 008 00 4
220	6 37 14 009 00 8
320	6 37 14 010 00 0

Carrying case

metal 690 x 240 x 160 mm



Order Reference 3 39 01 022 01 4





■ Sanding with Dust Extraction.

Dust is not only unpleasant and limiting to one's vision, but also hazardous to health and even potentially fatal, especially if coatings or corrosion-resistant primers are sanded, as in the case of repair and reconditioning work. Especially hazardous in this respect is that dust representing a health risk can be produced when everyday materials which are not dangerous under normal conditions, are being sanded.

For this reason FEIN has developed sanding systems which use highly effective dust extractors. The extraction starts as soon as the sander is switched on. You may choose between orbital, eccentric and rotary sanders, as well as the oscillating MULTIMASTER.

Some of these tools are also available in a pneumatic version.



Half-Sheet Finishing Sanders, 500 W

MSs 641 a

MSs 641 b

14 000/20 000

500 W
 2,8 kg

AT A GLANCE

Low-vibration orbital sander for medium-sized and large surface areas.

- Optimum external dust extraction for MSs 641 a :
- Low orbit rate and large stroke movement for rough sanding applications.

for MSs 641 b :

- High orbit rate and small working stroke for delicate sanding applications.

Order Reference Type		7 229 16 MSs 641 a	7 229 17 MSs 641 b
Input	W	500	500
Strokes	R.P.M.	14 000	20 000
Stroke	mm	5	2,4
Hose connection Ø	mm	32	32
Cable with plug	m	4	4
Net weight	kg	2,8	2,8
Sanding pad	mm	115 x 225	115 x 225

Price includes:

1 sanding pad, 1 dust bag, 1 additional handle

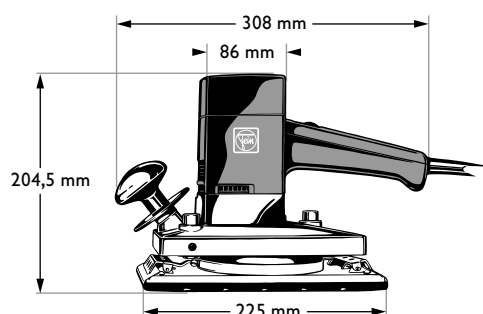

Accessories on page 168.

Sanding with quick-release clamping

Sanding Sheets

perforated, 115x280 mm

Application:	wood, paints, filler, car paints, FRP, plastics
Quality:	full synthetic resin-bonded, medium binding, "beige" corundum
Special characteristics:	significantly reduces clogging

Grit	Pack/quantity	Part Number
150	50	6 37 16 042 01 4
280	50	6 37 16 046 01 3
320	50	6 37 16 047 01 7
400	50	6 37 16 048 01 5

Sanding with quick-release hook and loop

Sanding Sheets

perforated, 115x228 mm

Application:	wood, paints, filler, car paints, FRP, plastics, metal
Quality:	full synthetic resin-bonded, corundum
Special characteristics:	very stable, high sanding capacity

Grit	Pack/quantity	Part Number
40	50	6 37 16 065 01 8
60	50	6 37 16 066 01 1
80	50	6 37 16 067 01 5
100	50	6 37 16 068 01 3
120	50	6 37 16 069 01 7
150	50	6 37 16 070 01 9
180	50	6 37 16 071 01 8
220	50	6 37 16 072 01 1
240	50	6 37 16 053 01 7
320	50	6 37 16 055 01 9

Sanding pad

for quick-action clamping

Order Reference 6 38 06 122 03 7

with hook and loop fastener

Order Reference 6 38 06 122 02 1

Hook and loop fastener

for quick-attachment



Order Reference 3 14 26 041 00 3

General accessory

Adaptor

Ø 27 mm



Order Reference 3 05 20 050 01 5

Ø 32 mm

Order Reference 3 05 20 050 02 1

required for the connection of the vacuum cleaner FEIN Dustex.

FEIN Dust Extractor, movable

for wet and dry use, with automatic switch-on facility, incl. suction hose 3,5 m long, Ø 32 mm



Order Reference 9 20 18 223 01 3

Detailed information on "dust-free sanding" and extensive accessories for the FEIN vacuum cleaner can be found in the chapter Accessories / Vacuum cleaner

Carrying case

metal
400 x 400 x 130 mm



Order Reference 3 39 01 032 01 3



Random Orbit Sander 380 W

MSf 636-1
pneumatic

Order Reference	7 220 78	
Type	MSf 636-1	
Input	W	380
Speed, no load	R.P.M.	7500
Stroke	mm	8,4
Hose connection Ø	mm	32
Connector thread backing pad	UNF	$5/16''$ -24
Cable with plug	m	5
Net weight	kg	1,7
Sanding pad Ø	mm	150

Price includes:

1 eccentric head Ø 150 mm, 1 backing pad, medium, Ø 150 mm, 1 suction wheel guard, 1 set of keys

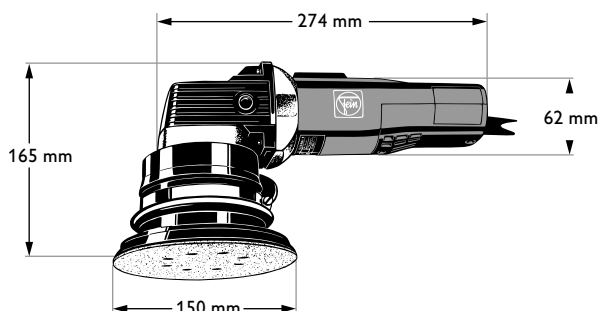

	150 mm		7500
	380 W		1,7 kg

AT A GLANCE

Universal eccentric grinder for coarse and fine grinding of medium and small surfaces.

- Excellent handling and low-vibration operation.
- Top sanding performance on every material.
- Sanding sheets rapidly fixed with velcro fastenings.
- Perfect direct dust suction.

Accessories on page 171.

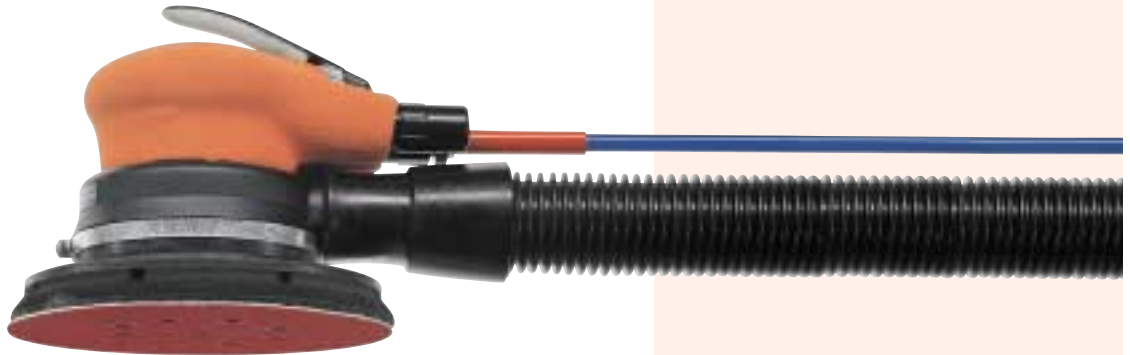

■ Pneumatic Random Orbit Sander

M 10 000-5
pneumatic

M 10 000-6
pneumatic

Order Reference Type		7 520 15 M 10 000-5	7 520 16 M 10 000-6
Operating pressure	bar	6	6
Air consumption	m ³ /min	0,51	0,51
Speed, no load	R.P.M.	10 000	10 000
Stroke	mm	5	5
Hose connection Ø	mm	32	32
Connector thread backing pad	UNF	5/16" -24	5/16" -24
Hose size Ø	mm	6	6
Net weight	kg	1,2	1,2
Sanding pad Ø	mm	125	150

Price includes:

1 suction wheel guard, 1 air hose, 1 key
for M 10 000-5:

1 sanding pad Ø 125 mm

for M 10 000-6:

1 sanding pad Ø 150 mm

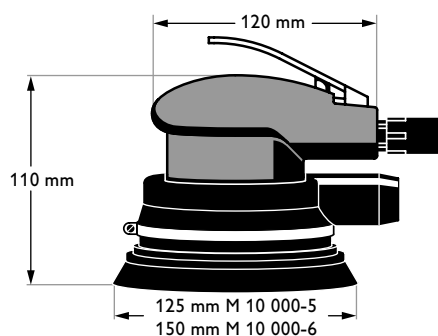

125/150 mm $\frac{x}{min}$ 10 000

1,2 kg

AT A GLANCE

- Excellent handling and low-vibration operation.
- Top sanding performance on every material.
- Sanding sheets rapidly fixed with velcro fastenings.
- Perfect direct dust suction.
- Very quiet-running rotating piston air engine.

Accessories on page 171.



Sanding with Ø 150 mm

Sanding Sheets

perforated, Ø 150 mm, with quick-release hook and loop fastening

Applications:		metal, car shells, solders, welds, FRP	wood, paints, car paints, filler, FRP, plastics	wood, paints, filler, car paints, FRP, plastics	wood, metal, car shells, welds
Quality:		high-performance sanding cloth, full synth. resin-bonded, corundum	full synth. resin-bonded, corundum	full synth. resin-bonded, corundum	full synth. resin-bonded light-binding, corundum
Special characteristics:		very stable, high sanding capacity	significantly reduced clogging, flexible	highly flexible	high sanding capacity
Grit	Pack/ quantity	Part Number 6 37 28...	Part Number 6 37 28...	Part Number 6 37 27...	Part Number 6 37 28...
40	50	...009 01 4			...072 01 2
60	50	...010 01 6			...073 01 6
80	50	...056 01 3	...074 01 4		
100	50	...054 01 6	...011 01 5		
120	50		...084 01 3		
150	50		...012 01 8	...118 01 1	
180	50		...013 01 2	...119 01 5	
220	50		...014 01 0	...120 01 7	
240	50		...015 01 4	...121 01 6	
280	50		...016 01 7	...122 01 9	
320	50		...017 01 1	...123 01 3	
400	50		...061 01 0	...124 01 1	

Sanding with Ø 125 mm

Sanding Sheets

perforated, Ø 125 mm, with quick-release hook and loop fastening

Application:		metal, car shells, soldered points, welds, FRP	wood, paints, car paints, filler, FRP, plastics	wood, paints, car paints, filler, FRP, plastics
Quality:		high-performance sanding cloth, full synth. resin-bonded, corundum	full synth. resin-bonded, medium binding, corundum	full synth. resin-bonded, medium binding, corundum
Special characteristics:		very stable, high sanding capacity	significantly reduced clogging, flexible	highly flexible
Grit	Pack/ quantity	Part Number 6 37 28...	Part Number 6 37 28...	Part Number 6 37 27...
60	50	...055 01 0		
80	50		...001 01 6	...107 01 4
100	50		...002 01 9	
150	50		...003 01 3	
180	50		...004 01 1	...110 01 8
220	50		...005 01 5	...111 01 7
240	50		...006 01 8	...112 01 0
280	50		...007 01 2	...113 01 4
320	50		...008 01 0	...114 01 2
400	50		...058 01 5	



Sanding Ø 150 mm

Eccentric head

Ø 150 mm, for MSf 636-1

Order Reference 3 12 07 103 01 3

Sanding pad

Ø 150 mm, with holes, with hook and loop fastener hard



Order Reference 6 38 06 101 02 0

medium

Order Reference 6 38 06 090 02 3

soft

Order Reference 6 38 06 114 02 4

Hook and loop fastener

Order Reference 3 14 26 030 00 5

Polishing Ø 150 mm

Lambskin

with hook and loop fastening quick-attachment



Ø mm
150 **Order Reference 6 37 23 009 00 4**

Sanding Ø 125 mm

Eccentric head

Ø 125 mm for MSf 636-1

Order Reference 3 12 07 109 01 4

Sanding pad

Ø 125 mm, with holes with hook and loop fastener, hard



Order Reference 6 38 06 103 02 7

medium

Order Reference 6 38 06 088 02 7

soft

Order Reference 6 38 06 117 02 5

Ø 125 mm, without holes, soft

Order Reference 6 38 06 155 03 0

Hook and loop fastener

Order Reference 3 14 26 028 00 9

Sanding pad

Ø 125 mm for MSf 636-1, without holes, soft with hook and loop fastener, hard

Order Reference 6 38 06 155 03 0

Spare Velcro attachment 3 14 26 027 001.

Polishing Ø 125 mm

Lambskin

with hook and loop fastening quick-attachment



Ø mm
125 **Order Reference 6 37 23 008 00 0**

MSf 636-1 Sanding Ø 115 mm

Sanding sheets

without holes, Ø 115 mm Range of application: metal, car bodies, soldered points, weld, FRP Quality: fully synthetic-resin bonded, „red“ high sanding capacity

Grain		Order Reference
60	50	6 37 28 095 01 6
80	50	6 37 28 096 01 9
100	50	6 37 28 097 01 3
120	50	6 37 28 098 01 1

Eccentric head

Ø 115 mm



Order Reference 3 12 07 131 02 9

Sanding pad

Ø 115 mm, without holes, with hook and loop fastener, hard

Order Reference 6 38 06 167 02 0

General accessory

Bow

as additional handle for MSf 636-1

Order Reference 3 21 25 048 03 2

FEIN Dust Extractor, movable

for wet and dry use, with automatic switch-on facility, incl. suction hose 3,5 m long, Ø 32 mm



Order Reference 9 20 18 223 01 3

Detailed information on "dust-free sanding" and extensive accessories for the FEIN vacuum cleaner can be found in the chapter Accessories / Vacuum cleaner



Rotary Sander 1200 W

FSS 12-27 E
FEIN HIGH-POWER MOTOR

Order Reference	7 220 92	
Type	FSS 12-27 E	
Input	W	1200
Output	W	750
Speed, no load	R.P.M.	900-2700
Hose connection Ø	mm	32
Cable with plug	m	4
Net weight	kg	2,3
Sanding pad Ø	mm	150/200
Mounting thread	M	14

Price includes:

1 suction wheel guard, 1 additional handle

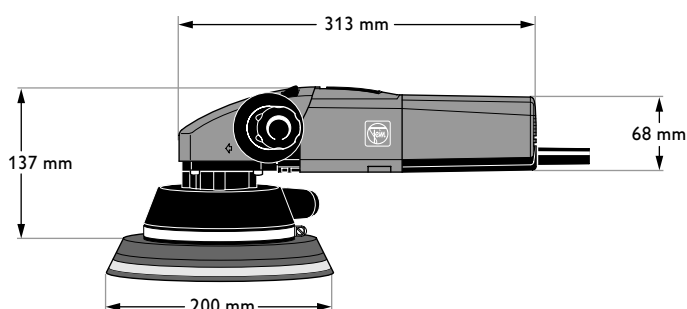

	150/200 mm		900-2700
	1200 W		2,3 kg

AT A GLANCE

Universal rotary sander for sanding and polishing applications.

- HIGH-POWER-MOTOR for unmatched performance and durability.
- For superfine sanding applications on medium and large-scale surfaces.
- Sanding sheets rapidly fixed with velcro fastenings.
- Perfect direct dust suction.
- Speed control to ensure ideal performance for all applications and optimum application of the tool.
- Ergonomic grip-hood for fatigue-free and comfortable working.
- Self-start lock to prevent injuries.

Accessories on page 174.

Sanding with Ø 200 mm

Sanding Sheets

perforated, Ø 200 mm, with quick-release hook and loop fastening

Application:	Fibre glass reinforced materials	metal, car shells, solders, welds, FRP	metal, car shells, solders, welds, FRP
Quality:	full synthetic resin-bonded, silicon carbide	high-performance sanding cloth, full synth. resin-bonded, corundum	full synthetic resin-bonded, corundum
Special characteristics:	long service life, extremely high sanding capacity	very stable, very high sanding capacity	stable, high sanding capacity

Grit	Pack/ quantity	Part Number	Part Number	Part Number
16	50	6 37 28 024 01 9		
36	50	6 37 28 025 01 3		
60	50		6 37 28 082 01 1	6 37 28 077 01 5
80	50		6 37 28 083 01 5	6 37 28 078 01 3

Application: metal, car paints

Quality: full synth. resin-bonded, medium binding, corundum

Special characteristics: significantly reduced clogging

Grit	Pack/ quantity	Part Number
80	50	6 37 28 057 01 7
100	50	6 37 28 027 01 0
150	50	6 37 28 081 01 8
180	50	6 37 28 028 01 8
220	50	6 37 28 029 01 2
240	50	6 37 28 030 01 4
280	50	6 37 28 031 01 3

Sanding pad

Ø 200 mm, with holes, with hook and loop fastener hard



Order Reference 6 38 06 102 02 3

medium

Order Reference 6 38 06 095 02 1

extra soft

Order Reference 6 38 06 118 02 3

Hook and loop fastener

Order Reference 3 14 26 033 00 1

Sanding with Ø 150 mm

Sanding Sheets

Ø 150 mm, perforated, with quick-release and loop fastening

Application:	Fibre glass-reinforced materials	wood, paints, filler, FRP, plastics, car paints	wood, metal, car shells, welds
Quality:	full synth. resin-bonded, silicon carbide	full synth. resin-bonded, medium binding, corundum	full synthetic resin-bonded, corundum
Special characteristics:	long service life, extremely high sanding capacity	significantly reduced clogging, flexible	high sanding capacity

Grit	Pack/ quantity	Part Number	Part Number	Part Number
16	50	6 37 28 020 01 5		
36	50	6 37 28 021 01 4		
60	50			6 37 28 022 01 7
100	50		6 37 28 023 01 1	

Sanding pad

Ø 150 mm, with holes, with hook and loop fastener hard



Order Reference 6 38 06 116 02 1

extra soft

Order Reference 6 38 06 166 02 6

Hook and loop fastener

Order Reference 3 14 26 031 00 4

Polishing

Lambskin

with hook and loop fastening quick-attachment



Ø	Order Reference
mm	
150	6 37 23 009 00 4
200	6 37 23 010 00 6

General accessory

FEIN Dust Extractor, movable

for wet and dry use, with automatic switch-on facility, incl. suction hose 3,5 m long, Ø 32 mm



Order Reference 9 20 18 223 01 3

Detailed information on "dust-free sanding" and extensive accessories for the FEIN vacuum cleaner can be found in the chapter Accessories / Vacuum cleaner

